

# SYSTEM DOCUMENT FOR XAN4CDXA - APPLICATION AREA YYORDER

## Table of contents

LEGENDS.....	1
Document Source.....	2
Selected Options.....	3
Overview Structure Chart (Detailed) for gestione ordini.....	4
Data Model Diagram (Normal) for gestione ordini.....	11
Object List for gestione ordini .....	12
Data Model Diagram (Detailed) for CUSF.....	13
File Connection Details.....	14
Data Model Diagram (Detailed) for CUSTS.....	15
File Connection Details.....	16
Data Model Diagram (Detailed) for PTYPES.....	17
File Connection Details.....	18
Data Model Diagram (Detailed) for QLETSRC.....	19
Data Model Diagram (Detailed) for PTYPES.....	20
Data Model Diagram (Detailed) for QLETSRC.....	21
Access path details for CUSF.....	22
Access path details for CUSTS.....	23
Access path details for PTYPES.....	24
Access path details for PTYPES.....	25
File Field Details for CUSF.....	26
File Field Details for CUSFL3.....	29
File Field Details for CUSTS.....	32
File Field Details for CUSTSL3.....	34
File Field Details for PTYPES.....	36
File Field Details for CUSTSL3.....	37
File Field Details for PTYPES.....	39
File Field Details for CUSFL3.....	40
File Field Details for QLETSRC.....	43
Object Where Used for CUSF.....	44
Object Where Used for CUSTS.....	48
Object Where Used for OE001DF.....	53
Object Where Used for PTYPES.....	54
Object Where Used for QLETSRC.....	55
Object Where Used for OE001.....	56
Object Where Used for OE001DF.....	57
Object Where Used for CUSTSL3.....	58
Object Where Used for PTYPES.....	59
Object Where Used for CUSLET.....	60
Object Where Used for CUSLET1.....	61
Object Where Used for LETN1.....	62
Object Where Used for CUSFL3.....	63
Object Where Used for WKCUSL.....	66
Object Where Used for QLETSRC.....	67
Object Where Used for CUSLETSQ.....	68
Object Where Used for WKCUS8EF.....	69
Object Where Used for WKCUS8E.....	70
Object Where Used for WKCUS8P.....	71
Data Flow Diagram (Normal) for CUSF.....	72

Annotation for CUSF.....	72
Data Flow Diagram (Normal) for CUSTS.....	77
Data Flow Diagram (Normal) for PYPES.....	80
Data Flow Diagram (Normal) for QLETSRC.....	81
Annotation for QLETSRC.....	81
Data Flow Diagram (Normal) for OE001.....	83
Annotation for OE001.....	83
Data Flow Diagram (Normal) for CUSTSL3.....	85
Data Flow Diagram (Normal) for PYPES.....	86
Data Flow Diagram (Normal) for CUSLET.....	87
Data Flow Diagram (Normal) for CUSLET1.....	88
Data Flow Diagram (Normal) for LETN1.....	89
Data Flow Diagram (Normal) for CUSFL3.....	90
Data Flow Diagram (Normal) for WKCUSL.....	93
Data Flow Diagram (Normal) for QLETSRC.....	94
Data Flow Diagram (Normal) for CUSLETSQ.....	95
Data Flow Diagram (Normal) for WKCUS8EF.....	96
Data Flow Diagram (Normal) for WKCUS8E.....	97
Data Flow Diagram (Normal) for WKCUS8P.....	98
Structure Chart Diagram (Normal) for OE001 .....	99
Annotation for OE001.....	99
Structure Chart Diagram (Normal) for CUSLET .....	101
Structure Chart Diagram (Normal) for CUSLET1 .....	102
Structure Chart Diagram (Normal) for LETN1 .....	103
Structure Chart Diagram (Normal) for WKCUSL .....	104
Structure Chart Diagram (Normal) for CUSLETSQ .....	105
Structure Chart Diagram (Normal) for WKCUS8EF .....	106
Structure Chart Diagram (Normal) for WKCUS8E .....	107
Structure Chart Diagram (Normal) for WKCUS8P .....	108
Screen Design for OE001.....	109
Screen Design for OESFLC (OE00101G).....	109
Field List for Format OESFLC (OE00101G).....	110
Report Layout for WKCUS8P.....	111
Report Layout for WKCUS8P (RPG).....	111
Business Rules for OE001.....	112
Business Rules for OE001DF.....	115
Business Rules for PYPES.....	116
Business Rules for LETN1.....	117
Business Rules for QLETSRC.....	118
Business Rules for CUSLETSQ.....	119
Business Rules for WKCUS8EF.....	120
Business Rules for WKCUS8E.....	122
Source for CUSF.....	126
Source for CUSFL3.....	129
Source for CUSTS.....	130
Source for CUSTSL3.....	134
Source for OE001DF.....	135
Source for PYPES.....	138
Source for QLETSRC.....	139
Source for OE001.....	140
Source for OE001DF.....	143
Source for CUSTSL3.....	144
Source for PYPES.....	145
Source for CUSLET.....	146

Source for CUSLET1.....	147
Source for LETN1.....	148
Source for CUSFL3.....	149
Source for WKCUSL.....	150
Source for QLETSRC.....	151
Source for CUSLETSQ.....	152
Source for WKCUS8EF.....	153
Source for WKCUS8E.....	155
Source for WKCUS8P.....	164
Program Structure Chart for OE001.....	165
Program Structure Chart for CUSLET.....	166
Program Structure Chart for CUSLET1.....	167
Program Structure Chart for LETN1.....	168
Program Structure Chart for WKCUSL.....	169
Program Structure Chart for CUSLETSQ.....	170
Program Structure Chart for WKCUS8EF.....	171
Program Structure Chart for WKCUS8E.....	172
Program Structure Chart for WKCUS8P.....	174
Index.....	175

## LEGENDS

### Structure Chart Diagram Legends

	Update
	Display
	Print
	Input
	Output
	Command
	Others
	Internal Routine
	Indeterminate
	Trigger
	Module

	Program Structure Operation
	Field Operation
	Commented Out && Excluded
	Blocked Comments

### Data Flow Diagram Legends

	Access Path
	Called
	Calling
	Input
	Internal Routine
	Output
	Update

### Data Model Diagram Legends

	Refer To
	Owned By
	Uni-Directional
	Multiple Rels
	Internal
	External
	Extended by
	Unrelated Files
	Join File Relations

### Program Structure Chart Diagram Legends

	Programs/Modules
	Subroutines/Procedures

### Source/Business Rules Legends

	Comment
	Call Operation
	File Operation

## ***Document Source***

Document generated for XAN4CDXA

(Application Area : YYORDER )

Generation time: 21 settembre 2023 10.09.37

## ***Selected Options***

1. Application Area OSC - Detailed (Level 8)
2. Application Area DMD - Normal
3. Application Area Diagram
4. Application Area Annotation
5. Object List
6. Data Model Diagram - Detailed
7. LF/Access Path details
8. File Field Details
9. Object Where Used
10. Data Flow Diagram - Normal with Annotation
11. Structure Chart - Normal with Annotation (Level 5)
12. Screen/Report Layout - Normal
13. Business Rules - Detailed
14. Source (Level 2)
15. Source Flow Chart (Level 1)
16. Program Structure Chart

**Overview Structure Chart (Detailed) for gestione ordini**

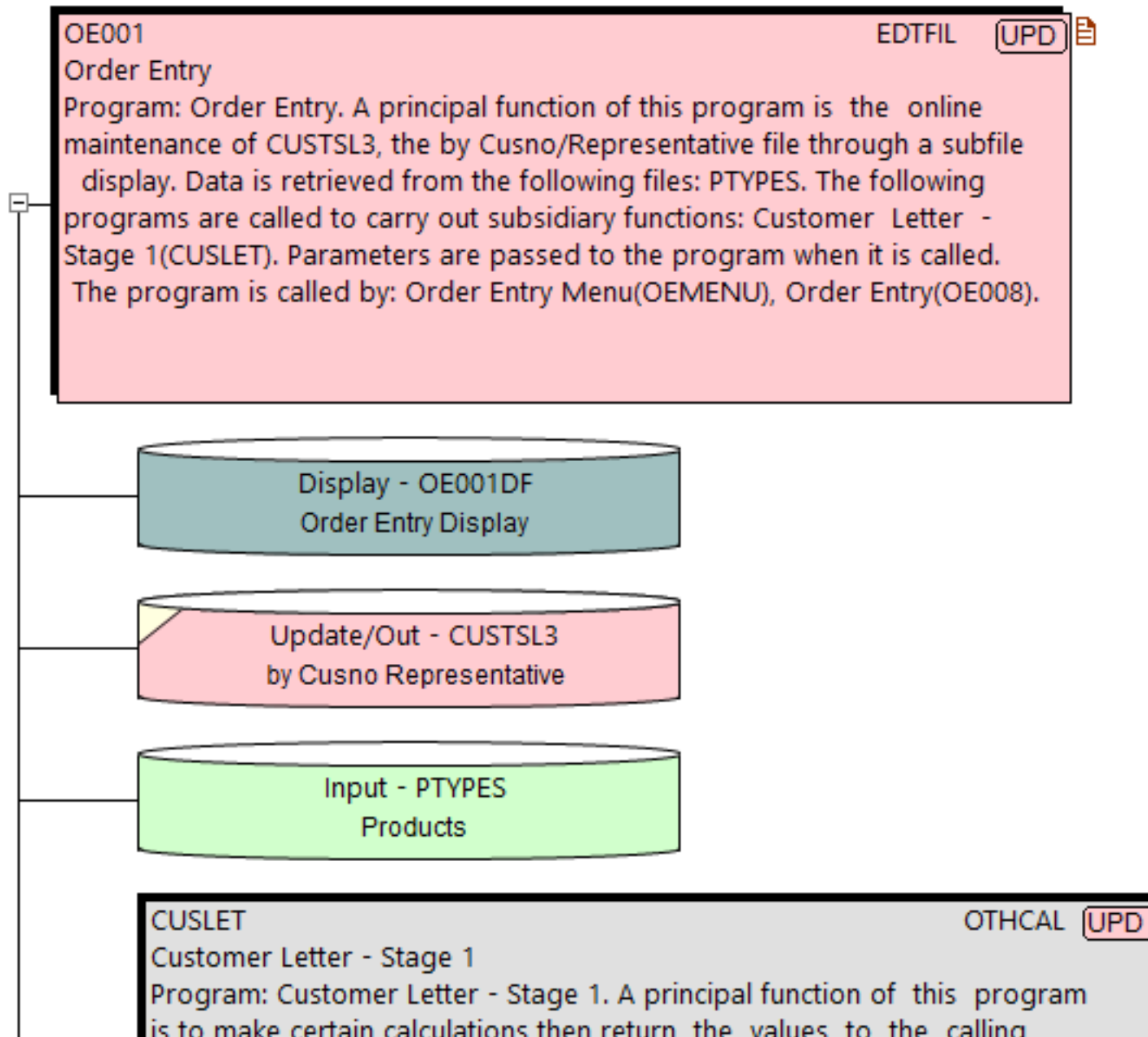

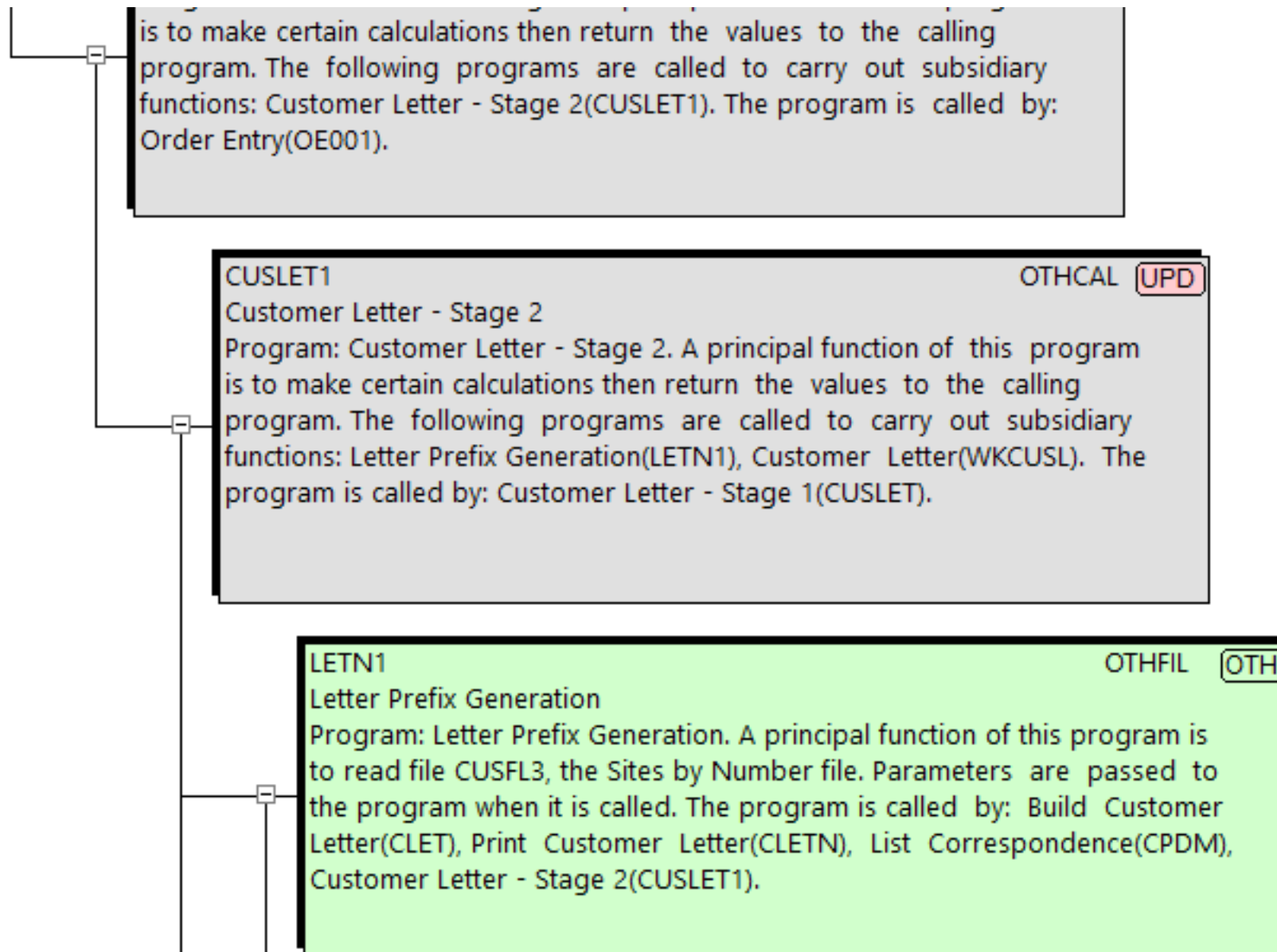



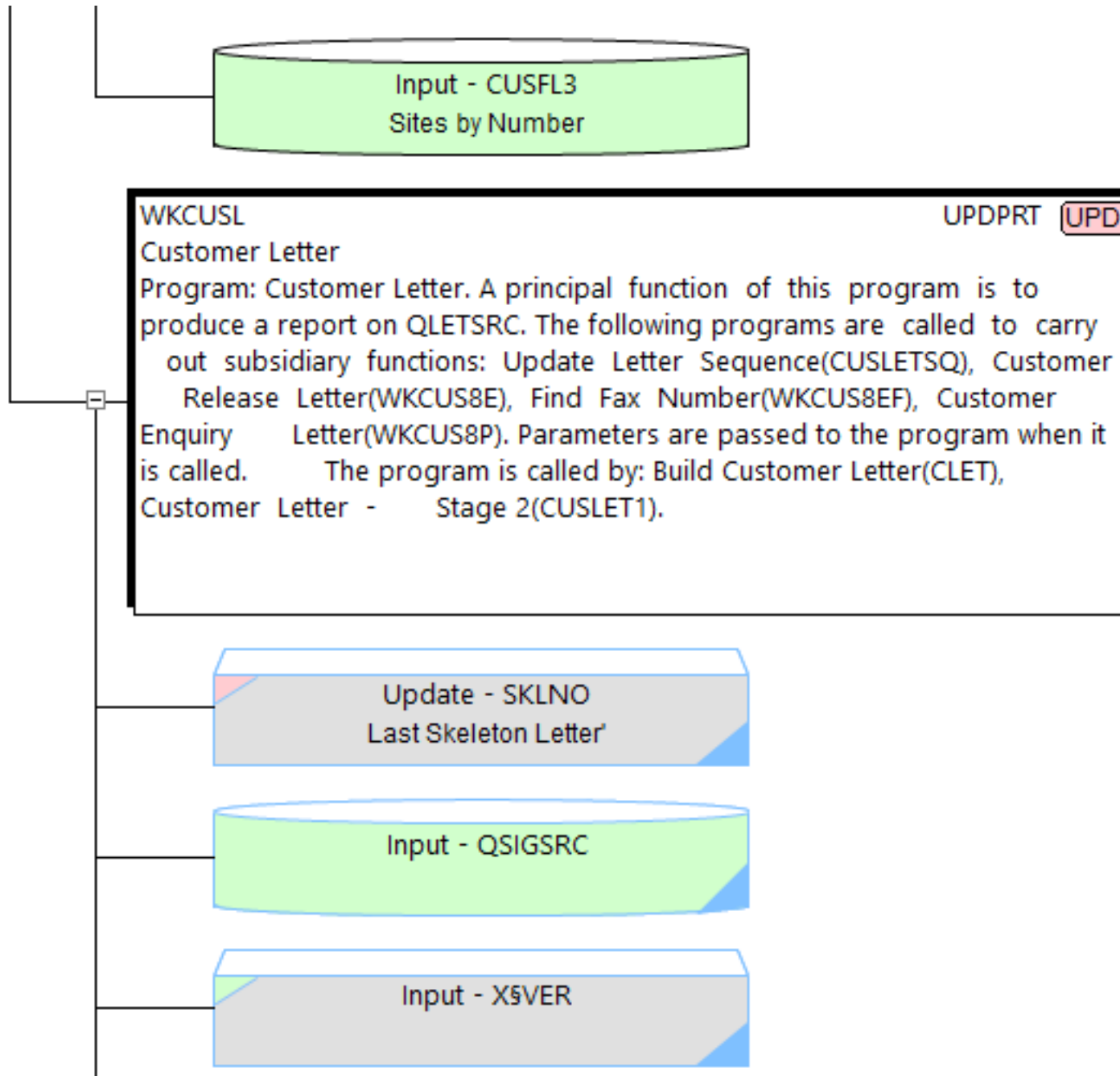

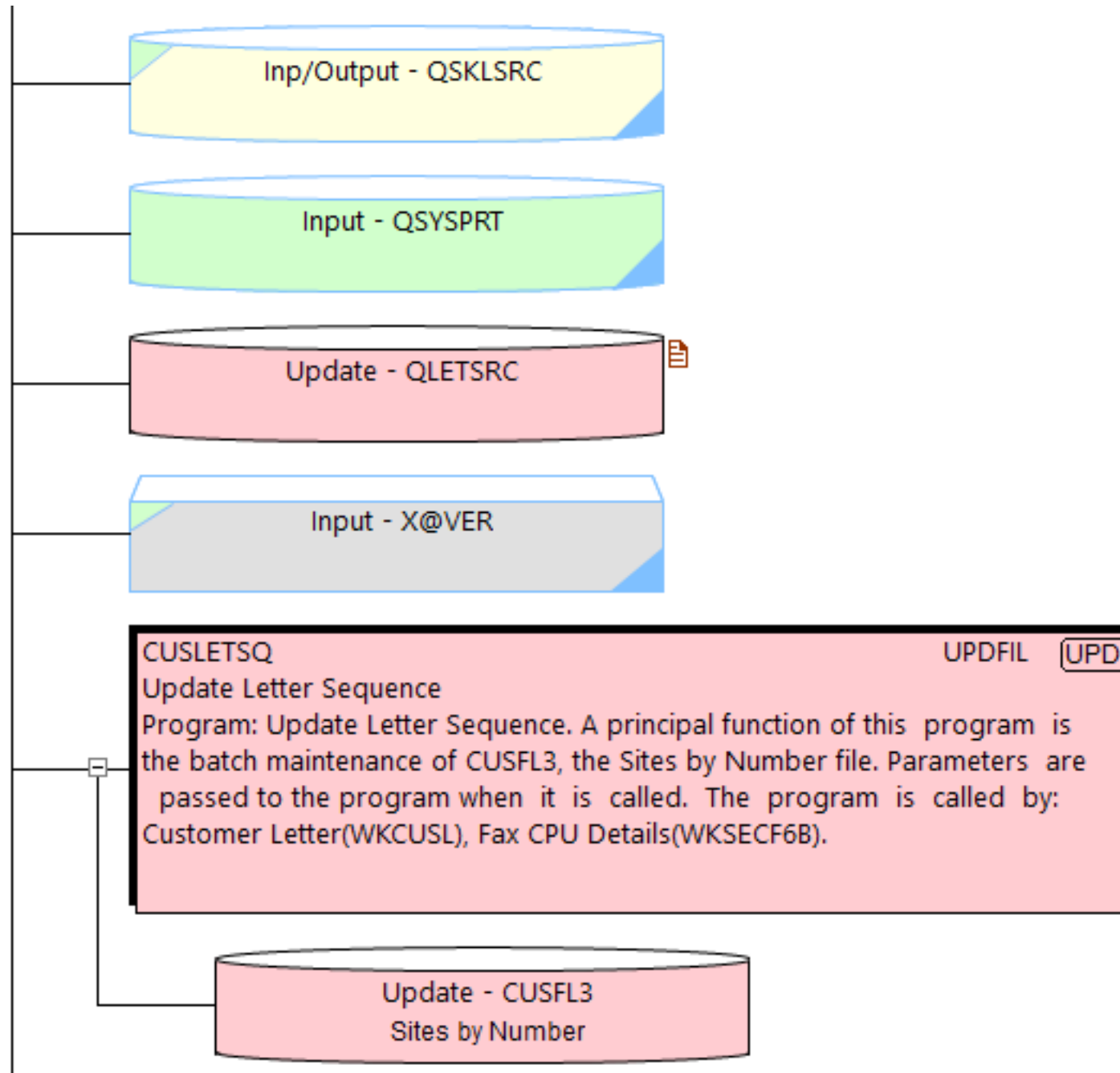

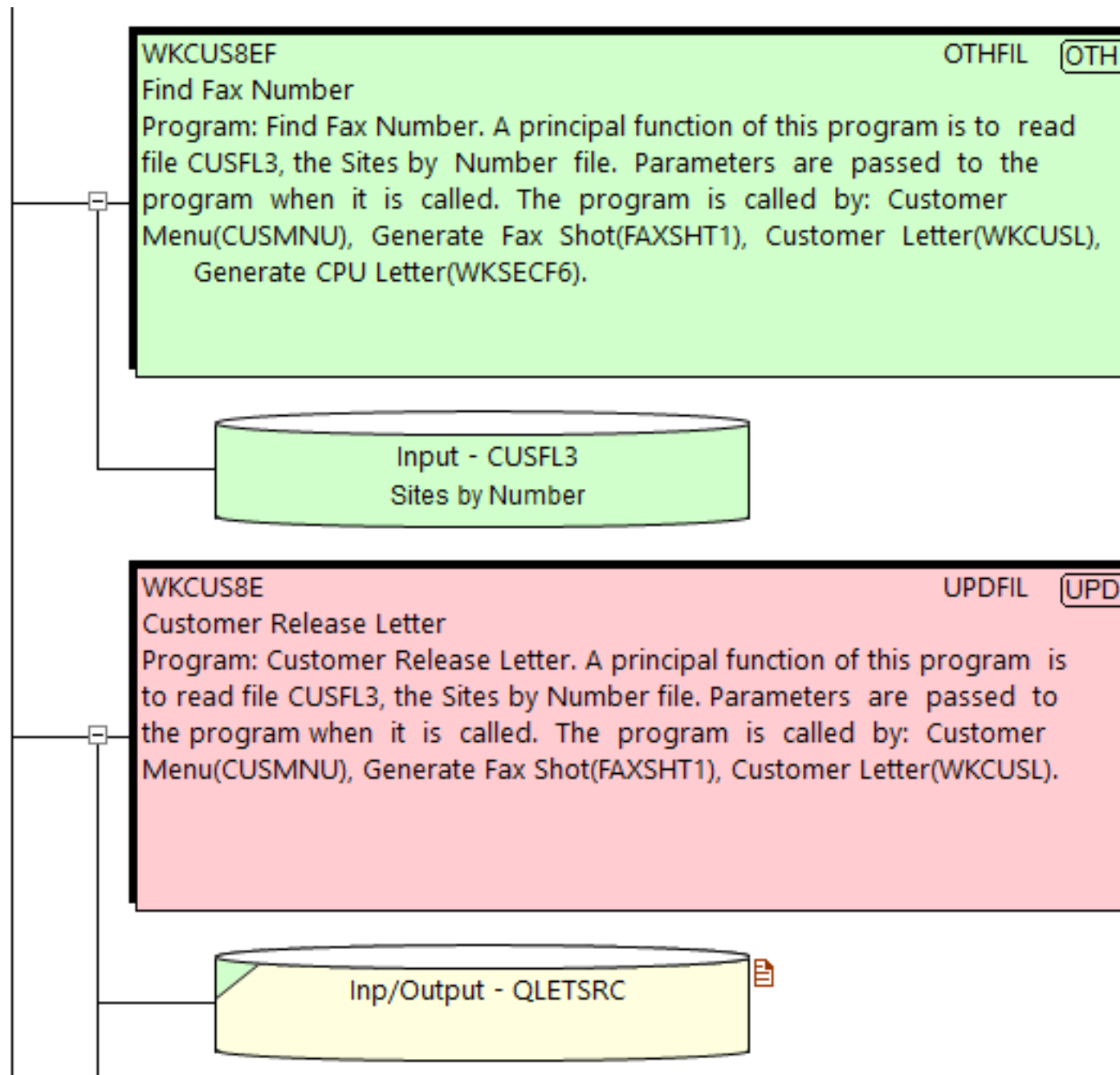

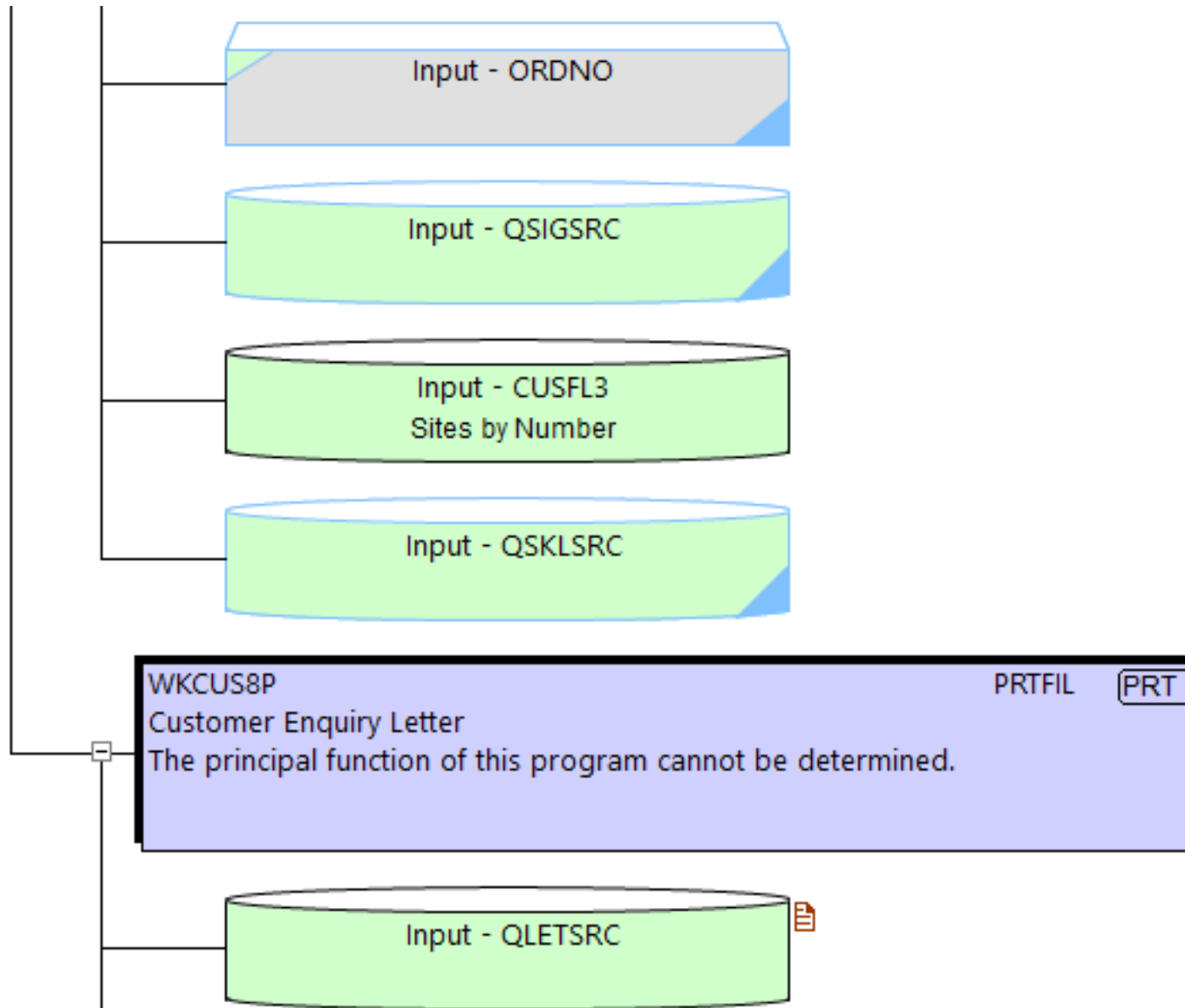

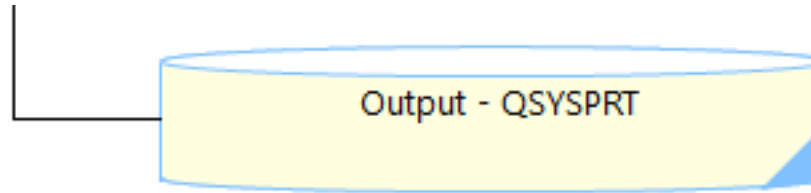

**Data Model Diagram (Normal) for gestione ordini**

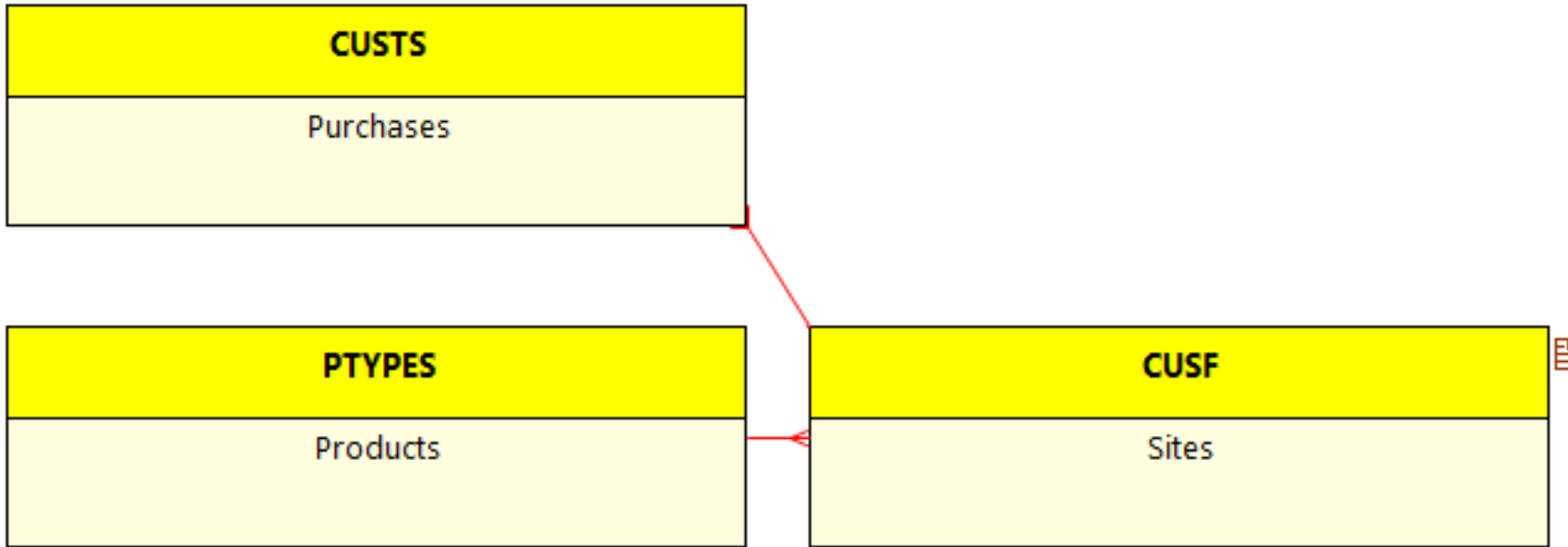

**Object List for gestione ordini**

Name	Type	Attribute	Description
CUSF	*FILE	PF	Sites
CUSFL3	*FILE	LF	Sites by Number
CUSTS	*FILE	PF	Purchases
CUSTSL3	*FILE	LF	by Cusno/Representative
OE001DF	*FILE	DSPF	Order Entry Display
PTYPES	*FILE	PF	Products
QLETSRC	*FILE	PF	
OE001	*PGM	RPG	Order Entry
OE001DF	*FILE	DSPF	Order Entry Display
CUSTSL3	*FILE	PF	by Cusno Representative
PTYPES	*FILE	PF	Products
CUSLET	*PGM	CLP	Customer Letter - Stage 1
CUSLET1	*PGM	CLP	Customer Letter - Stage 2
LETN1	*PGM	RPG	Letter Prefix Generation
CUSFL3	*FILE	PF	Sites by Number
WKCUSL	*PGM	CLP	Customer Letter
QLETSRC	*FILE	PF	
CUSLETSQ	*PGM	RPG	Update Letter Sequence
WKCUS8EF	*PGM	RPG	Find Fax Number
WKCUS8E	*PGM	RPG	Customer Release Letter
WKCUS8P	*PGM	RPG	Customer Enquiry Letter

**Data Model Diagram (Detailed) for CUSF**

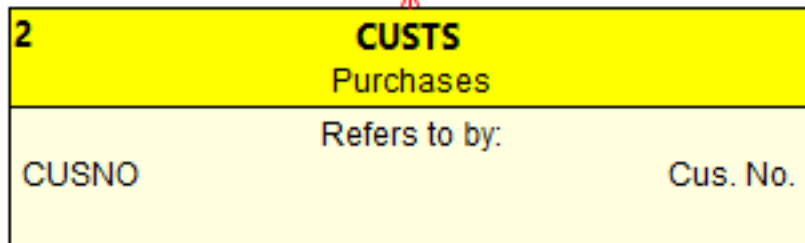
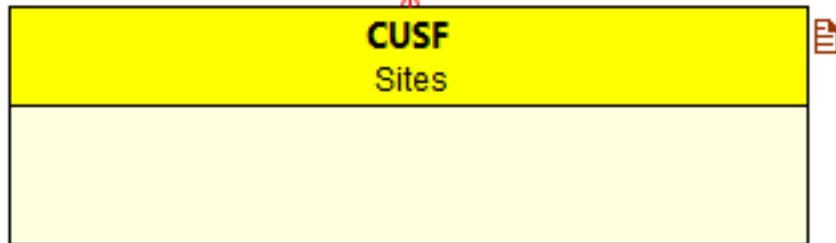
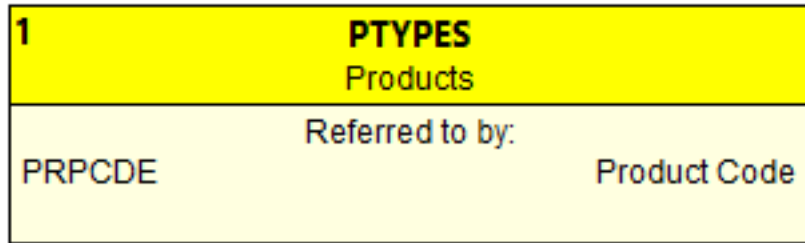



**1. File Connection Details**

Rel No.	Dependent File	Relation Type	Parent File	Dependent Fields	Parent Fields	Dep LF	Defining Program/View	Library
1	Sites	REFERS TO	Products	Product Code	Code	CUSFLA	OE006	XAN4CDEM
2	Purchases	REFERS TO	Sites	Prospect No	Cus. No.	CUSTSL3	ZBTRNHST	XAN4CDEM

**Data Model Diagram (Detailed) for CUSTS**

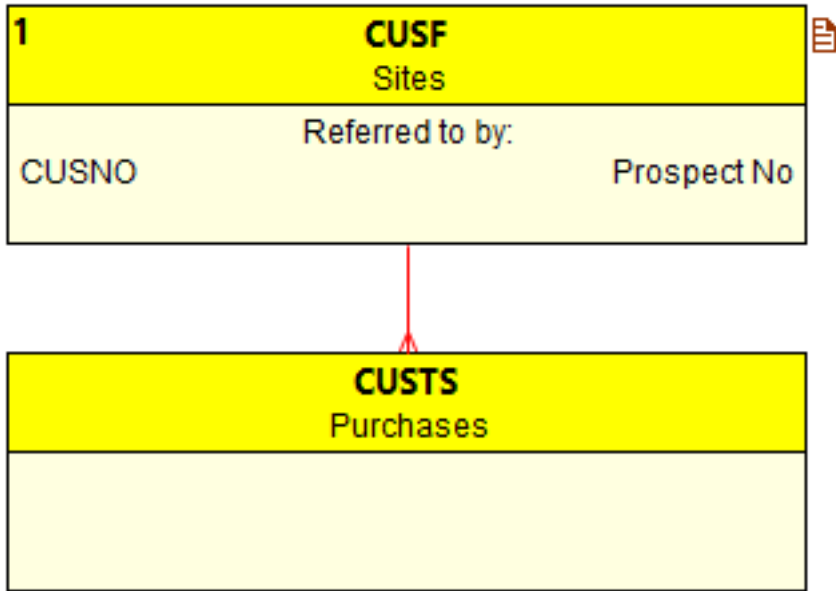

**1. File Connection Details**

Rel No.	Dependent File	Relation Type	Parent File	Dependent Fields	Parent Fields	Dep LF	Defining Program/View	Library
1	Purchases	REFERS TO	Sites	Prospect No	Cus. No.	CUSTSL3	ZBTRNHST	XAN4CDEM

**Data Model Diagram (Detailed) for PTYPES**

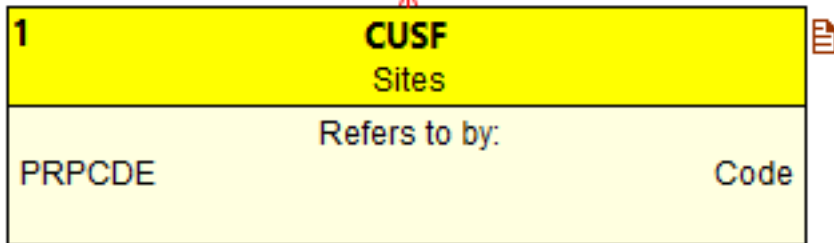
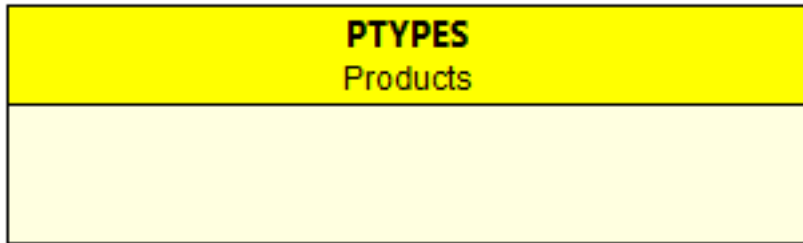

**1. File Connection Details**

Rel No.	Dependent File	Relation Type	Parent File	Dependent Fields	Parent Fields	Dep LF	Defining Program/View	Library
1	Sites	REFERS TO	Products	Product Code	Code	CUSFLA	OE006	XAN4CDEM

**Data Model Diagram (Detailed) for QLETSRC**

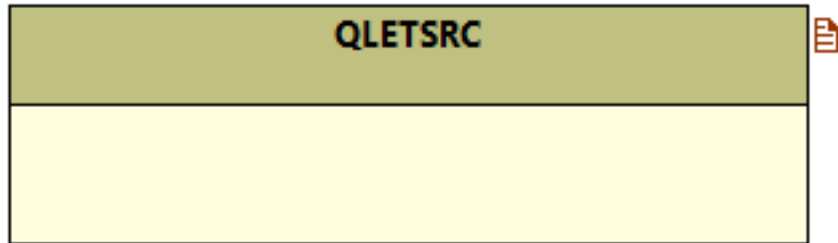

## ***Data Model Diagram (Detailed) for PTYPES***

[Previously documnted](#)

***Data Model Diagram (Detailed) for QLETSRC***

[Previously documnted](#)



**Access path details for CUSF**

Access Path	Text	Unique Keys	Select/Omit	Field Names
CUSF	Sites	N	N	
CUSFL1	Sites by Name	N	N	CNAME
CUSFL3	Sites by Number	Y	N	CUSNO
CUSFLA	Sites by Product	N	N	PRPCDE,CNAME
CUSFLB	Sites by Orig.List	N	N	LSLCDE,CNAME
CUSFLC	Sites by Salesperson	N	N	SINIT,CNAME
CUSFLD	Sites by Validator	N	N	VINIT,CNAME
CUSFLE	Sites by Organisation	N	N	ORG,CNAME
CUSFL2	Sites by Status	N	N	STATUS,CNAME
CUSFL5	Sites by Dist.& Status	N	N	DSDCDE,STATUS,CNAME
CUSFL6	Sites By Dist.& Name	N	N	DSDCDE,CNAME
CUSFL7	Sites by Last Cnt.Date	N	Y	LCTDAT,STATUS,CNAME
CUSFL8	Sites by Next Cnt.Date	N	N	APDATE,CNAME
CUSFL9	Sites by Fax No.	N	Y	FAXNO

**Access path details for CUSTS**

Access Path	Text	Unique Keys	Select/Omit	Field Names
CUSTS	Purchases	Y	N	XWBCCD
CUSTSL1	by Cus Grp/Customer	N	N	XWBNCD,XWBCCD
CUSTSL2	by Representative/Customer	N	N	PERSON,XWBCCD
CUSTSL3	by Cusno/Representative	N	N	CUSNO,PERSON
CUSTSL4	by Distributor/Customer	N	N	DSDCDE,XWBCCD
CUSTSL5	by Statement/Customer	N	N	XWB2CD,XWBCCD

**Access path details for PTYPES**

Access Path	Text	Unique Keys	Select/Omit	Field Names
PTYPES	Products	N	N	PRPCDE

## ***Access path details for PTYPES***

[Previously documnted](#)

**File Field Details for CUSF**

Mnemonic	Long Name	Type	Length	Dec.Pos.	Inp.Buf.Pos.	Headings
CNAME	Company	Character	34		00001	Company
DSDCDE	Distributor	Character	2		00035	Distributor
STATUS	Sts	Character	1		00037	Status
TELNO	Phone	Character	17		00038	Phone
EXTN	Extn	Character	6		00055	Extn.
LCTDAT	Last_Cnt_Date	Zoned Decimal	6	0	00061	Last Contact Date
APDATE	Next_Cnt_Date	Zoned Decimal	6	0	00067	Next Contact Date
USERNM	Contact	Character	34		00073	Contact
SALUT	Salutation	Character	34		00107	Salutation
JTITLE	Job_Title	Character	34		00141	Job Title
FAXNO	Fax_No	Character	15		00175	Fax. No.
EMAIL	Email	Character	40		00190	Email
WEBSIT	Website	Character	40		00230	Website
ADD1	Address_1	Character	34		00270	Address 1
ADD2	Address_2	Character	34		00304	Address 2
ADD3	Address_3	Character	34		00338	Address 3
ADD4	Address_4	Character	34		00372	Address 4
CNTRY	Country	Character	25		00406	Country

## System Document for XAN4CDXA - Application Area YYORDER

PSCD	Post_Code	Character	8		00431	Post Code
CUSNO	Cus_No	Packed Decimal	5	0	00439	Cus. No.
CMMNT1	Comment_Line_1	Character	40		00442	Comment Line 1
CMMNT2	Comment_Line_2	Character	40		00482	Comment Line 2
CMMNT3	Comment_Line_3	Character	40		00522	Comment Line 3
DOCRCD	Doc_Sent	Character	3		00562	Docn.sent
DOC2	Doc_Sent	Character	3		00565	Lit. Sent 2.
DOC3	Doc_Sent	Character	3		00568	Lit. Sent 3.
DOC4	Doc_Sent	Character	3		00571	Lit. Sent 4.
DOC5	Doc_Sent	Character	3		00574	Lit. Sent 5.
DOC6	Doc_Sent	Character	3		00577	Lit. Sent 6.
OLDMCH	Mch	Character	2		00580	Machine
PRPCDE	Product_Code	Character	2		00582	Product Code
LSLCDE	Orig_List	Character	2		00584	Orig. List Code
PREFIX	Doc_Prfl	Character	5		00586	Doc.Prefix:
LLET SQ	Last_Let	Packed Decimal	3	0	00591	Last letter no.
SPREQ	Spec_Req	Character	40		00593	Special Requirements
RISC	Cisc_Risc_Both	Character	1		00633	Cisc/Risc/Both
ALTTEL	Alt_Tel_No_1	Character	17		00634	Alt.Tel.No.1
ALTTL2	Alt_Tel_No_2	Character	17		00651	Alt.Tel.No.2
SINIT	Salesperson	Character	3		00668	Salesperson
VERYFD	Verified	Character	1		00671	Verified?

System Document for XAN4CDXA - Application Area YYORDER

VINIT	Verified_By	Character	3		00672	Verified By
VFDATE	Verification_Date	Zoned Decimal	6	0	00675	Verification Date
CRTNAM	Created_By	Character	10		00681	Created By:
CRTDAT	Creation_Date	Zoned Decimal	6	0	00691	Creation Date
UPDNAM	Updated_By	Character	10		00697	Updated By:
UPDDAT	Update_Date	Zoned Decimal	6	0	00707	Update Date
ORG	Organisation	Packed Decimal	5	0	00713	Organisation

**File Field Details for CUSFL3**

Mnemonic	Long Name	Type	Length	Dec.Pos.	Inp.Buf.Pos.	Headings
CNAME	Company	Character	34		1	CNAME
DSDCDE	Distributor	Character	2		35	DSDCDE
STATUS	Status	Character	1		37	Sts
TELNO	Phone	Character	17		38	TELNO
EXTN	Extn.	Character	6		55	EXTN
LCTDAT	Last Contact Date	Zoned Decimal	6	0	61	Last Cnt Date
APDATE	Next Contact Date	Zoned Decimal	6	0	67	Next Cnt Date
USERNM	Contact	Character	34		73	USERNM
SALUT	Salutation	Character	34		107	SALUT
JTITLE	Job Title	Character	34		141	JTITLE
FAXNO	Fax. No.	Character	15		175	FAXNO
EMAIL	Email	Character	40		190	EMAIL
WEBSIT	Website	Character	40		230	WEBSIT
ADD1	Address 1	Character	34		270	ADD1
ADD2	Address 2	Character	34		304	ADD2
ADD3	Address 3	Character	34		338	ADD3
ADD4	Address 4	Character	34		372	ADD4
CNTRY	Country	Character	25		406	CNTRY



## System Document for XAN4CDXA - Application Area YYORDER

PSCD	Post Code	Character	8		431	PSCD
CUSNO	Cus. No.	Packed Decimal	5	0	439	Cus. No.
CMMNT1	Comment Line 1	Character	40		442	CMMNT1
CMMNT2	Comment Line 2	Character	40		482	CMMNT2
CMMNT3	Comment Line 3	Character	40		522	CMMNT3
DOCRCD	Docn.sent	Character	3		562	Doc. Sent
DOC2	Lit. Sent 2.	Character	3		565	Doc. Sent
DOC3	Lit. Sent 3.	Character	3		568	Doc. Sent
DOC4	Lit. Sent 4.	Character	3		571	Doc. Sent
DOC5	Lit. Sent 5.	Character	3		574	Doc. Sent
DOC6	Lit. Sent 6.	Character	3		577	Doc. Sent
OLDMCH	Machine	Character	2		580	Mch
PRPCDE	Product Code	Character	2		582	PRPCDE
LSLCDE	Orig. List Code	Character	2		584	Orig List
PREFIX	Doc.Prefix:	Character	5		586	Doc. Prf.
LLETSQ	Last letter no.	Packed Decimal	3	0	591	Last Let.
SPREQ	Special Requirements	Character	40		593	Spec Req.
RISC	Cisc/Risc/Both	Character	1		633	RISC
ALTTEL	Alt.Tel.No.1	Character	17		634	ALTTEL
ALTTL2	Alt.Tel.No.2	Character	17		651	ALTTL2
SINIT	Salesperson	Character	3		668	SINIT
VERYFD	Verified?	Character	1		671	VERYFD

System Document for XAN4CDXA - Application Area YYORDER

VINIT	Verified By	Character	3		672	VINIT
VFDATE	Verification Date	Zoned Decimal	6	0	675	VFDATE
CRTNAM	Created By:	Character	10		681	CRTNAM
CRTDAT	Creation Date	Zoned Decimal	6	0	691	CRTDAT
UPDNAM	Updated By:	Character	10		697	UPDNAM
UPDDAT	Update Date	Zoned Decimal	6	0	707	UPDDAT
ORG	Organisation	Packed Decimal	5	0	713	ORG

**File Field Details for CUSTS**

Mnemonic	Long Name	Type	Length	Dec.Pos.	Inp.Buf.Pos.	Headings
XWBCCD	Customer	Character	11		00001	Customer
XWG4TX	Name	Character	40		00012	Name
XWB2CD	Statement_Account	Character	11		00052	Statement Account
XWB3CD	Related_Account	Character	11		00063	Related Account
XWHITX	Tax_Reg	Character	15		00074	Tax Reg
XWE0NB	Bank	Packed Decimal	9	0	00089	Bank
XWJUN0	Bank_A_c	Packed Decimal	15	0	00094	Bank A/c
XWDVCD	Forex	Character	3		00102	Forex
XWBNCD	CusGrp	Character	2		00105	CusGrp
PERSON	Rep	Character	3		00107	Rep
DSDCDE	Distributor	Character	2		00110	Distributor
XWBTCD	Terms	Character	3		00112	Terms
XWGIVA	Credit_Limit	Packed Decimal	15	2	00115	Credit Limit
XWAOCD	Stl_Dsc	Character	3		00123	Stl Dsc
XWBBCD	Int	Character	3		00126	Int
XWG4T0	Cr_Guarantee	Character	10		00129	Cr Guarantee
XWC7ST	B_O	Character	1		00139	B/O
XWDAST	Lang	Character	1		00140	Lang

## System Document for XAN4CDXA - Application Area YYORDER

XWBPD0	Date_Loaded	Date	10		00141	Date Loaded
XWBAD0	Chg_Date	Date	10		00151	Chg-Date
XWARDT	Last_Sale	Date	10		00161	Last Sale
XWF0VA	Amt_Last_Sale	Packed Decimal	15	2	00171	Amt Last Sale
XWASDT	Date_Last_Pay	Date	10		00179	Date Last Pay
XWF0V0	Last_Pay	Packed Decimal	15	2	00189	Last Pay
XWBQDT	Date_Last_Stmt	Date	10		00197	Date Last Stmt
XWF1VA	Curr_Pay	Packed Decimal	15	2	00207	Curr Pay
XWF1V0	Curr_Claim	Packed Decimal	15	2	00215	Curr Claim
XWF2VA	Curr_Sls	Packed Decimal	15	2	00223	Curr Sls
XWF3VA	Curr_Cost	Packed Decimal	15	2	00231	Curr Cost
XWF4VA	Ytd_Sales	Packed Decimal	15	2	00239	Ytd Sales
XWF6VA	Last_Year_Sls	Packed Decimal	15	2	00247	Last Year Sls
XWIDV0	Balance	Packed Decimal	15	2	00255	Balance
XWGAVA	Current_Amt	Packed Decimal	15	2	00263	Current Amt
XWGBVA	X030_Days	Packed Decimal	15	2	00271	030 Days
XWGCVA	X060_Days	Packed Decimal	15	2	00279	060 Days
XWGDVA	X090_Days	Packed Decimal	15	2	00287	090 Days
XWGEVA	X120_Days	Packed Decimal	15	2	00295	120 Days
XWGFVA	X150_Days	Packed Decimal	15	2	00303	150 Days
XWGGVA	X180_Days	Packed Decimal	15	2	00311	180 Days
CUSNO	Prospect_No	Packed Decimal	5	0	00319	Prospect No

**File Field Details for CUSTSL3**

Mnemonic	Long Name	Type	Length	Dec.Pos.	Inp.Buf.Pos.	Headings
XWBCCD	Customer	Character	11		1	XWBCCD
XWG4TX	Name	Character	40		12	XWG4TX
XWB2CD	Statement Account	Character	11		52	XWB2CD
XWB3CD	Related Account	Character	11		63	XWB3CD
XWHITX	Tax Reg	Character	15		74	XWHITX
XWE0NB	Bank	Packed Decimal	9	0	89	XWE0NB
XWJUN0	Bank A/c	Packed Decimal	15	0	94	XWJUN0
XWDVCD	Forex	Character	3		102	XWDVCD
XWBNCD	CusGrp	Character	2		105	XWBNCD
PERSON	Rep	Character	3		107	PERSON
DSDCDE	Distributor	Character	2		110	DSDCDE
XWBTCD	Terms	Character	3		112	XWBTCD
XWGIVA	Credit Limit	Packed Decimal	15	2	115	XWGIVA
XWAOCD	Stl Dsc	Character	3		123	XWAOCD
XWBBCD	Int	Character	3		126	XWBBCD
XWG4T0	Cr Guarantee	Character	10		129	XWG4T0
XWC7ST	B/O	Character	1		139	XWC7ST
XWDAST	Lang	Character	1		140	XWDAST

## System Document for XAN4CDXA - Application Area YYORDER

XWBPD0	Date Loaded	Date	10		141	XWBPD0
XWBAD0	Chg-Date	Date	10		151	XWBAD0
XWARDT	Last Sale	Date	10		161	XWARDT
XWF0VA	Amt Last Sale	Packed Decimal	15	2	171	XWF0VA
XWASDT	Date Last Pay	Date	10		179	XWASDT
XWF0V0	Last Pay	Packed Decimal	15	2	189	XWF0V0
XWBQDT	Date Last Stmt	Date	10		197	XWBQDT
XWF1VA	Curr Pay	Packed Decimal	15	2	207	XWF1VA
XWF1V0	Curr Claim	Packed Decimal	15	2	215	XWF1V0
XWF2VA	Curr Sls	Packed Decimal	15	2	223	XWF2VA
XWF3VA	Curr Cost	Packed Decimal	15	2	231	XWF3VA
XWF4VA	Ytd Sales	Packed Decimal	15	2	239	XWF4VA
XWF6VA	Last Year Sls	Packed Decimal	15	2	247	XWF6VA
XWIDV0	Balance	Packed Decimal	15	2	255	XWIDV0
XWGAVA	Current Amt	Packed Decimal	15	2	263	XWGAVA
XWGBVA	030 Days	Packed Decimal	15	2	271	XWGBVA
XWGCVA	060 Days	Packed Decimal	15	2	279	XWGCVA
XWGDVA	090 Days	Packed Decimal	15	2	287	XWGDVA
XWGEVA	120 Days	Packed Decimal	15	2	295	XWGEVA
XWGFVA	150 Days	Packed Decimal	15	2	303	XWGFVA
XWGGVA	180 Days	Packed Decimal	15	2	311	XWGGVA
CUSNO	Prospect No	Packed Decimal	5	0	319	CUSNO

**File Field Details for PTYPES**

Mnemonic	Long Name	Type	Length	Dec.Pos.	Inp.Buf.Pos.	Headings
PRPCDE	Code	Character	2		00001	Code
PDESCF	Description	Character	34		00003	Description
PQTY	Quantity	Packed Decimal	7	2	00037	Quantity
PUNT	Unit	Character	20		00041	Unit
PPRC	Price	Packed Decimal	7	2	00061	Price

**File Field Details for CUSTSL3**

Mnemonic	Long Name	Type	Length	Dec.Pos.	Inp.Buf.Pos.	Headings
XWBCCD	Customer	Character	11		1	XWBCCD
XWG4TX	Name	Character	40		12	XWG4TX
XWB2CD	Statement Account	Character	11		52	XWB2CD
XWB3CD	Related Account	Character	11		63	XWB3CD
XWHITX	Tax Reg	Character	15		74	XWHITX
XWE0NB	Bank	Packed Decimal	9	0	89	XWE0NB
XWJUN0	Bank A/c	Packed Decimal	15	0	94	XWJUN0
XWDVCD	Forex	Character	3		102	XWDVCD
XWBNCD	CusGrp	Character	2		105	XWBNCD
PERSON	Rep	Character	3		107	PERSON
DSDCDE	Distributor	Character	2		110	DSDCDE
XWBTCD	Terms	Character	3		112	XWBTCD
XWGIVA	Credit Limit	Packed Decimal	15	2	115	XWGIVA
XWAOCD	Stl Dsc	Character	3		123	XWAOCD
XWBBCD	Int	Character	3		126	XWBBCD
XWG4T0	Cr Guarantee	Character	10		129	XWG4T0
XWC7ST	B/O	Character	1		139	XWC7ST
XWDAST	Lang	Character	1		140	XWDAST



System Document for XAN4CDXA - Application Area YYORDER

XWBPD0	Date Loaded	Date	10		141	XWBPD0
XWBAD0	Chg-Date	Date	10		151	XWBAD0
XWARDT	Last Sale	Date	10		161	XWARDT
XWF0VA	Amt Last Sale	Packed Decimal	15	2	171	XWF0VA
XWASDT	Date Last Pay	Date	10		179	XWASDT
XWF0V0	Last Pay	Packed Decimal	15	2	189	XWF0V0
XWBQDT	Date Last Stmt	Date	10		197	XWBQDT
XWF1VA	Curr Pay	Packed Decimal	15	2	207	XWF1VA
XWF1V0	Curr Claim	Packed Decimal	15	2	215	XWF1V0
XWF2VA	Curr Sls	Packed Decimal	15	2	223	XWF2VA
XWF3VA	Curr Cost	Packed Decimal	15	2	231	XWF3VA
XWF4VA	Ytd Sales	Packed Decimal	15	2	239	XWF4VA
XWF6VA	Last Year Sls	Packed Decimal	15	2	247	XWF6VA
XWIDV0	Balance	Packed Decimal	15	2	255	XWIDV0
XWGAVA	Current Amt	Packed Decimal	15	2	263	XWGAVA
XWGBVA	030 Days	Packed Decimal	15	2	271	XWGBVA
XWGCVA	060 Days	Packed Decimal	15	2	279	XWGCVA
XWGDVA	090 Days	Packed Decimal	15	2	287	XWGDVA
XWGEVA	120 Days	Packed Decimal	15	2	295	XWGEVA
XWGFVA	150 Days	Packed Decimal	15	2	303	XWGFVA
XWGGVA	180 Days	Packed Decimal	15	2	311	XWGGVA
CUSNO	Prospect No	Packed Decimal	5	0	319	CUSNO

## ***File Field Details for PTYPES***

[Previously documnted](#)

**File Field Details for CUSFL3**

Mnemonic	Long Name	Type	Length	Dec.Pos.	Inp.Buf.Pos.	Headings
CNAME	Company	Character	34		1	CNAME
DSDCDE	Distributor	Character	2		35	DSDCDE
STATUS	Status	Character	1		37	Sts
TELNO	Phone	Character	17		38	TELNO
EXTN	Extn.	Character	6		55	EXTN
LCTDAT	Last Contact Date	Zoned Decimal	6	0	61	Last Cnt Date
APDATE	Next Contact Date	Zoned Decimal	6	0	67	Next Cnt Date
USERNM	Contact	Character	34		73	USERNM
SALUT	Salutation	Character	34		107	SALUT
JTITLE	Job Title	Character	34		141	JTITLE
FAXNO	Fax. No.	Character	15		175	FAXNO
EMAIL	Email	Character	40		190	EMAIL
WEBSIT	Website	Character	40		230	WEBSIT
ADD1	Address 1	Character	34		270	ADD1
ADD2	Address 2	Character	34		304	ADD2
ADD3	Address 3	Character	34		338	ADD3
ADD4	Address 4	Character	34		372	ADD4
CNTRY	Country	Character	25		406	CNTRY

## System Document for XAN4CDXA - Application Area YYORDER

PSCD	Post Code	Character	8		431	PSCD
CUSNO	Cus. No.	Packed Decimal	5	0	439	Cus. No.
CMMNT1	Comment Line 1	Character	40		442	CMMNT1
CMMNT2	Comment Line 2	Character	40		482	CMMNT2
CMMNT3	Comment Line 3	Character	40		522	CMMNT3
DOCRCD	Docn.sent	Character	3		562	Doc. Sent
DOC2	Lit. Sent 2.	Character	3		565	Doc. Sent
DOC3	Lit. Sent 3.	Character	3		568	Doc. Sent
DOC4	Lit. Sent 4.	Character	3		571	Doc. Sent
DOC5	Lit. Sent 5.	Character	3		574	Doc. Sent
DOC6	Lit. Sent 6.	Character	3		577	Doc. Sent
OLDMCH	Machine	Character	2		580	Mch
PRPCDE	Product Code	Character	2		582	PRPCDE
LSLCDE	Orig. List Code	Character	2		584	Orig List
PREFIX	Doc.Prefix:	Character	5		586	Doc. Prf.
LLETSQ	Last letter no.	Packed Decimal	3	0	591	Last Let.
SPREQ	Special Requirements	Character	40		593	Spec Req.
RISC	Cisc/Risc/Both	Character	1		633	RISC
ALTTEL	Alt.Tel.No.1	Character	17		634	ALTTEL
ALTTL2	Alt.Tel.No.2	Character	17		651	ALTTL2
SINIT	Salesperson	Character	3		668	SINIT
VERYFD	Verified?	Character	1		671	VERYFD

## System Document for XAN4CDXA - Application Area YYORDER

VINIT	Verified By	Character	3		672	VINIT
VFDATE	Verification Date	Zoned Decimal	6	0	675	VFDATE
CRTNAM	Created By:	Character	10		681	CRTNAM
CRTDAT	Creation Date	Zoned Decimal	6	0	691	CRTDAT
UPDNAM	Updated By:	Character	10		697	UPDNAM
UPDDAT	Update Date	Zoned Decimal	6	0	707	UPDDAT
ORG	Organisation	Packed Decimal	5	0	713	ORG

## ***File Field Details for QLETSRC***

[Previously documnted](#)

**Object Where Used for CUSF**

Object	Type	Attribute	Text	Usage	Library	Last Used
CB906R	*PGM	RPG	Back-out account	File Updated By Program	XAN4CDEM	00/00/00
CNTDELRCO	*PGM	RPGLE		File Updated By Program/Delete Operation	XAN4CDEM	00/00/00
CONSTPROC	*PGM	CLE	PROC_WITH_ALL_CONSTANTS	File Read By Program	XAN4CDEM	00/00/00
CONUPD0	*PGM	RPGLE	Revert Back Customer Info	File Updated By Program	XAN4CDEM	00/00/00
CONUPD1	*PGM	RPGLE	Update Customer Info - Version 1	File Updated By Program	XAN4CDEM	00/00/00
CONUPD2	*PGM	RPGLE	Update Customer Info - Version 2	File Updated By Program	XAN4CDEM	00/00/00
CRTVAR01	*PGM	RPGLE	Embedded SQL with Create Variable Statement	File Read By Program	XAN4CDEM	00/00/00
CUSCPY	*PGM	RPG	Customer Copy	File Read/Written To By Program	XAN4CDEM	00/00/00
CUSFMINT	*PGM	RPGLE	Customer Site Maintenance	File Updated By Program	XAN4CDEM	00/00/00
CUSFMOLD	*PGM	RPGLE	Customer Site Maintenance	File Updated By Program	XAN4CDEM	00/00/00
CUSFSEL	*PGM	RPGLE	Customer Site Selection	File Read By Program	XAN4CDEM	00/00/00
CUSLETSQ	*PGM	RPG	Update Letter Sequence	File Updated By Program	XAN4CDEM	00/00/00
CUSREAD	*PGM	RPGLE	Test Sequential Read options	File Read By Program	XAN4CDEM	00/00/00
CUSREADDEL	*PGM	RPGLE	TEST SEQUENTIAL READ OPTIONS	File Updated By Program/Delete Operation	XAN4CDEM	00/00/00
CUSRGZ	*PGM	RPG	Reorganize Customer File	File Updated By Program	XAN4CDEM	00/00/00

## System Document for XAN4CDXA - Application Area YYORDER

CUSTMNTJR	*PGM	RPGLE	Customer Detail Maintenance	File Read By Program	XAN4CDEM	00/00/00
CUSTMNT1	*PGM	RPGLE	Customer Detail Maintenance	File Read By Program	XAN4CDEM	00/00/00
CUSTMNT1_0	*PGM	RPGLE	Customer Detail Maintenance	File Read By Program	XAN4CDEM	00/00/00
CUSTMNT1_1	*PGM	RPGLE	Customer Detail Maintenance	File Read By Program	XAN4CDEM	00/00/00
CUSTMNT1_2	*PGM	RPGLE	Customer Detail Maintenance	File Read By Program	XAN4CDEM	00/00/00
DREPORT	*PGM	RPG	Distributor Report	File Read By Program	XAN4CDEM	00/00/00
DSPPTYPES	*PGM	RPGLE	Display Product	File Read By Program	XAN4CDEM	00/00/00
ESQLINDRF1	*PGM	RPGLE	Fully Free RPG ESQL VWU Indirect References	File Read By Program	XAN4CDEM	00/00/00
ESQLINDRF2	*PGM	RPGLE	Fully Free RPG ESQL VWU Indirect References	File Read By Program	XAN4CDEM	00/00/00
ESQLINDRF3	*PGM	RPGLE	Indirect references from Function Arguments	File Updated/Written To By Program	XAN4CDEM	00/00/00
FAXERR1	*PGM	RPG	Faxshot Errors Part 1.	File Updated By Program	XAN4CDEM	00/00/00
FAXERR2	*PGM	RPG	Faxshot Errors Part 2.	File Updated By Program	XAN4CDEM	00/00/00
FAXNOS1	*PGM	RPG	Generate Fax Numbers	File Read By Program	XAN4CDEM	00/00/00
FAXSHT1	*PGM	RPG	Generate Fax Shot	File Updated By Program	XAN4CDEM	00/00/00
GCNTAC1	*PGM	RPG	Generate Prospect Record	File Read By Program	XAN4CDEM	00/00/00
GCUST1	*PGM	RPG	Generate Purchase Record	File Read By Program	XAN4CDEM	00/00/00
GETDCOD	*PGM	RPGLE	Find Customer Distributor Code	File Read By Program	XAN4CDEM	00/00/00
GETDCODS	*MODULE	RPGLE	Find Customer Distributor Code (SRVPGM)	File Read By Module	XAN4CDEM	00/00/00
GETDCODS	*SRVPGM	RPGLE		File Read By Service	XAN4CDEM	00/00/00



## System Document for XAN4CDXA - Application Area YYORDER

LETN1	*PGM	RPG	Letter Prefix Generation	File Read By Program	XAN4CDEM	00/00/00
OE002	*PGM	RPG	Order Enquiry	File Read By Program	XAN4CDEM	00/00/00
OE006	*PGM	RPG	Print Invoices	File Read By Program	XAN4CDEM	00/00/00
OE008	*PGM	RPG	Order Entry	File Read By Program	XAN4CDEM	00/00/00
SECFO	*PGM	RPG	Reorganize Codes File	File Read/Written To By Program	XAN4CDEM	00/00/00
SECFOCLP	*PGM	CLP	Security Report	File Read By Program	XAN4CDEM	00/00/00
SQLFUNC01	*SRVPGM	CLE	SQLFUNC01	File Read By Service	XAN4CDEM	00/00/00
SQLFUNC02	*SRVPGM	CLE	SQLFUNC02	File Read By Service	XAN4CDEM	00/00/00
SQLFUNC03	*SRVPGM	CLE	SQLFUNC03	File Read By Service	XAN4CDEM	00/00/00
TRIGGER1	*PGM	RPGLE	Dummy Trigger program	File Read by Trigger program	XAN4CDEM	00/00/00
VWUOUTCOMP	*SRVPGM	CLE	TEST_VWU_OUTSIDE_COMP_STMT	File Read By Service	XAN4CDEM	00/00/00
VWUTSTPROC	*PGM	CLE	PROC_TEST_VWU_ON_SQL_QUERIES	File Written To By Program	XAN4CDEM	00/00/00
WCUSTP	*PGM	RPGLE	Print Customer Detail	File Read By Program	XAN4CDEM	00/00/00
WKCUSP	*PGM	RPG	Summary Customer Report	File Read By Program	XAN4CDEM	00/00/00
WKCUS8E	*PGM	RPG	Customer Release Letter	File Read By Program	XAN4CDEM	00/00/00
WKCUS8EF	*PGM	RPG	Find Fax Number	File Read By Program	XAN4CDEM	00/00/00
WKSECF6	*PGM	RPG	Generate CPU Letter	File Read By Program	XAN4CDEM	00/00/00
WWCONHDR	*PGM	RPGLE	Work with Orders	File Read By Program	XAN4CDEM	00/00/00
WWCUSF	*PGM	RPGLE	Work with Customer Sites	File Updated/Written To By Program/Delete Operation	XAN4CDEM	00/00/00

## System Document for XAN4CDXA - Application Area YYORDER

WWCUSTS	*PGM	RPGLE	Work with Customers	File Read By Program	XAN4CDEM	00/00/00
WWCUSTSARR	*PGM	RPGLE	Work with Customers	File Read By Program	XAN4CDEM	00/00/00
WWCUSTS_0	*PGM	RPGLE	Work with Customers	File Read By Program	XAN4CDEM	00/00/00
WWCUSTS_1	*PGM	RPGLE	Work with Customers	File Read By Program	XAN4CDEM	00/00/00
WWCUSTS2	*PGM	RPGLE	Work with Customers	File Read By Program	XAN4CDEM	00/00/00
WWTRNHST	*PGM	RPGLE	Work with transaction history	File Read By Program	XAN4CDEM	00/00/00
ZAUDASTATU	*PGM	RPGLE	Audit ASTATUS file	File Read By Program	XAN4CDEM	00/00/00
ZAUDCUSF	*PGM	RPGLE	Audit CUSF file	File Read By Program	XAN4CDEM	00/00/00
ZAUDDISTS	*PGM	RPGLE	Audit DISTS file	File Read By Program	XAN4CDEM	00/00/00
ZAUDLISTS	*PGM	RPGLE	Audit LISTS file	File Read By Program	XAN4CDEM	00/00/00
ZAUDORGS	*PGM	RPGLE	Audit ORGS file	File Read By Program	XAN4CDEM	00/00/00
ZAUDPTYPES	*PGM	RPGLE	Audit PTYPES file	File Read By Program	XAN4CDEM	00/00/00
ZBCONHDR	*PGM	CBL	Work with Orders - Cobol vers.	File Read By Program	XAN4CDEM	00/00/00
ZBCUSFMNT	*PGM	CBL	Customer Site Maintenance	File Updated/Written To By Program	XAN4CDEM	00/00/00
ZBCUSTS	*PGM	CBL	Work with customer - Cobol vers.	File Read By Program	XAN4CDEM	00/00/00
ZBPRNCUSF	*PGM	CBL	Print Customer Details	File Read By Program	XAN4CDEM	00/00/00
ZBTRNHST	*PGM	CBL	Work with transaction history	File Read By Program	XAN4CDEM	00/00/00

**Object Where Used for CUSTS**

Object	Type	Attribute	Text	Usage	Library	Last Used
CBCUSTSD	*FILE	DSPF	Work with Customers	File Referred to by File	XAN4CDEM	00/00/00
CNTDELRCDD	*PGM	RPGLE		File Updated By Program/Delete Operation	XAN4CDEM	00/00/00
CONUPD0	*PGM	RPGLE	Revert Back Customer Info	File Updated By Program	XAN4CDEM	00/00/00
CONUPD1	*PGM	RPGLE	Update Customer Info - Version 1	File Updated By Program	XAN4CDEM	00/00/00
CONUPD2	*PGM	RPGLE	Update Customer Info - Version 2	File Updated By Program	XAN4CDEM	00/00/00
CON001	*PGM	RPG	Contract Entry	File Read By Program	XAN4CDEM	00/00/00
CUSCPY	*PGM	RPG	Customer Copy	File Read/Written To By Program	XAN4CDEM	00/00/00
CUSMTH	*PGM	RPG	Update Maintenance Months	File Updated By Program	XAN4CDEM	00/00/00
CUSREAD	*PGM	RPGLE	Test Sequential Read options	File Read By Program	XAN4CDEM	00/00/00
CUSREADDEL	*PGM	RPGLE	TEST SEQUENTIAL READ OPTIONS	File Read By Program	XAN4CDEM	00/00/00
CUSTOMNTJR	*PGM	RPGLE	Customer Detail Maintenance	File Updated/Written To By Program	XAN4CDEM	00/00/00
CUSTOMNT1	*PGM	RPGLE	Customer Detail Maintenance	File Updated/Written To By Program	XAN4CDEM	00/00/00
CUSTOMNT1FF	*FILE	DSPF	Customer Detail Maintenance	File Referred to by File	XAN4CDEM	00/00/00
CUSTOMNT1FM	*FILE	DSPF	Customer Detail Maintenance	File Referred to by File	XAN4CDEM	00/00/00

## System Document for XAN4CDXA - Application Area YYORDER

CUSTMNT1_0	*PGM	RPGLE	Customer Detail Maintenance	File Updated/Written To By Program	XAN4CDEM	00/00/00
CUSTMNT1_1	*PGM	RPGLE	Customer Detail Maintenance	File Updated/Written To By Program	XAN4CDEM	00/00/00
CUSTMNT1_2	*PGM	RPGLE	Customer Detail Maintenance	File Updated/Written To By Program	XAN4CDEM	00/00/00
CUSTMN_1FM	*FILE	DSPF	Customer Detail Maintenance	File Referred to by File	XAN4CDEM	00/00/00
CUSTRPT01	*PGM	RPGLE	Customer Order Report Detail	File Read By Program	XAN4CDEM	00/00/00
CUSTRPT02	*PGM	RPGLE	Customer Transaction Report Detail	File Read By Program	XAN4CDEM	00/00/00
CUSTSR01	*FILE	PRTF	Customer Order Information	File Referred to by File	XAN4CDEM	00/00/00
CUSTSR02	*FILE	PRTF	File to Store Source File Informations	File Referred to by File	XAN4CDEM	00/00/00
CUSTSSEL	*PGM	RPGLE	Customer Selection	File Read By Program	XAN4CDEM	00/00/00
CUSUPD0	*PGM	RPGLE		File Updated By Program	XAN4CDEM	00/00/00
CUSUPD1	*PGM	RPGLE		File Updated By Program	XAN4CDEM	00/00/00
CUSUPD2	*PGM	RPGLE		File Updated By Program	XAN4CDEM	00/00/00
GCUST1	*PGM	RPG	Generate Purchase Record	File Written To By Program	XAN4CDEM	00/00/00
OE001	*PGM	RPG	Order Entry	File Updated/Written To By Program	XAN4CDEM	00/00/00
OE002	*PGM	RPG	Order Enquiry	File Read By Program	XAN4CDEM	00/00/00
OE004	*PGM	RPG	Customer Enquiry/Maintenance	File Updated/Written To By Program	XAN4CDEM	00/00/00
OE006	*PGM	RPG	Print Invoices	File Read By Program	XAN4CDEM	00/00/00

## System Document for XAN4CDXA - Application Area YYORDER

OE008	*PGM	RPG	Order Entry	File Updated/Written To By Program	XAN4CDEM	00/00/00
PRTWCUSTP	*PGM	RPGLE		File Read By Program	XAN4CDEM	00/00/00
PUR01	*PGM	RPG	Purchase Order Entry	File Read By Program	XAN4CDEM	00/00/00
QRY1	*QRYDFN	QRY	*Q	Query Reference	XAN4CDEM	00/00/00
SEC1	*PGM	RPG	Security Code Report	File Read By Program	XAN4CDEM	00/00/00
TSTPGM171	*PGM	RPGLE	To tst SQL statements	File Updated By Program/Delete Operation	XAN4CDEM	00/00/00
TSTPGM172	*PGM	RPGLE	To tst SQL statements	File Read By Program	XAN4CDEM	00/00/00
VWUTSTPROC	*PGM	CLE	PROC_TEST_VWU_ON_SQL_QUERIES	File Updated By Program	XAN4CDEM	00/00/00
WCONDETD	*FILE	DSPF	Work with Order Detail	File Referred to by File	XAN4CDEM	00/00/00
WCONHDRD	*FILE	DSPF	Work with Orders from WWCUSTS	File Referred to by File	XAN4CDEM	00/00/00
WCUSTP	*PGM	RPGLE	Print Customer Detail	File Read By Program	XAN4CDEM	00/00/00
WCUSTRD	*FILE	DSPF	Customer Detail Maintenance	File Referred to by File	XAN4CDEM	00/00/00
WCUSTRP	*FILE	PRTF	Print Customer Detail	File Referred to by File	XAN4CDEM	00/00/00
WCUSTSD	*FILE	DSPF	Work with Customer	File Referred to by File	XAN4CDEM	00/00/00
WCUSTSDA	*FILE	DSPF	Work with Customer - Display File	File Referred to by File	XAN4CDEM	00/00/00
WCUSTSDAFR	*FILE	DSPF	Work with Customer - Display File	File Referred to by File	XAN4CDEM	00/00/00
WCUSTSDARR	*FILE	DSPF	Work with Customer - Display File	File Referred to by File	XAN4CDEM	00/00/00
WCUSTSDFR	*FILE	DSPF	Work with Customer - Display File	File Referred to by File	XAN4CDEM	00/00/00
WCUSTSDFRR	*FILE	DSPF	Work with Customer - Display File	File Referred to by File	XAN4CDEM	00/00/00
WCUSTSD2	*FILE	DSPF	Work with Customers	File Referred to by File	XAN4CDEM	00/00/00

System Document for XAN4CDXA - Application Area YYORDER

WCUSTSD2FR	*FILE	DSPF	Work with Customers	File Referred to by File	XAN4CDEM	00/00/00
WTRNHSTD	*FILE	DSPF	Work with transaction history	File Referred to by File	XAN4CDEM	00/00/00
WWCONDET	*PGM	RPGLE	Work with Order Details	File Read By Program	XAN4CDEM	00/00/00
WWCONHDR	*PGM	RPGLE	Work with Orders	File Read By Program	XAN4CDEM	00/00/00
WWCUSTS	*PGM	RPGLE	Work with Customers	File Updated/Written To By Program/Delete Operation	XAN4CDEM	00/00/00
WWCUSTSARR	*PGM	RPGLE	Work with Customers	File Updated/Written To By Program/Delete Operation	XAN4CDEM	00/00/00
WWCUSTS_0	*PGM	RPGLE	Work with Customers	File Updated/Written To By Program/Delete Operation	XAN4CDEM	00/00/00
WWCUSTS_1	*PGM	RPGLE	Work with Customers	File Updated/Written To By Program/Delete Operation	XAN4CDEM	00/00/00
WWCUSTS2	*PGM	RPGLE	Work with Customers	File Updated/Written To By Program/Delete Operation	XAN4CDEM	00/00/00
WWTRNHST	*PGM	RPGLE	Work with transaction history	File Read By Program	XAN4CDEM	00/00/00
ZAUDCUSF	*PGM	RPGLE	Audit CUSF file	File Read By Program	XAN4CDEM	00/00/00
ZAUDCUSGRP	*PGM	RPGLE	Audit CUSGRP file	File Read By Program	XAN4CDEM	00/00/00
ZAUDCUSTS	*PGM	RPGLE	Audit CUSTS file	File Read By Program	XAN4CDEM	00/00/00
ZAUDDISTS	*PGM	RPGLE	Audit DISTS file	File Read By Program	XAN4CDEM	00/00/00
ZAUDSLMEN	*PGM	RPGLE	Audit SLMEN file	File Read By Program	XAN4CDEM	00/00/00
ZBCONDET	*PGM	CBL	Work with Order Details	File Read By Program	XAN4CDEM	00/00/00
ZBCONDETNW	*PGM	CBL	Work with Order Details -Long fields used	File Read By Program	XAN4CDEM	00/00/00

System Document for XAN4CDXA - Application Area YYORDER

ZBCONHDR	*PGM	CBL	Work with Orders - Cobol vers.	File Read By Program	XAN4CDEM	00/00/00
ZBCUSTS	*PGM	CBL	Work with customer - Cobol vers.	File Updated/Written To By Program	XAN4CDEM	00/00/00
ZBTRNHST	*PGM	CBL	Work with transaction history	File Read By Program	XAN4CDEM	00/00/00

**Object Where Used for OE001DF**

Object	Type	Attribute	Text	Usage	Library	Last Used
OE001	*PGM	RPG	Order Entry	File Read/Written To By Program	XAN4CDEM	00/00/00
OE008	*PGM	RPG	Order Entry	File Read/Written To By Program	XAN4CDEM	00/00/00



**Object Where Used for PTYPES**

Object	Type	Attribute	Text	Usage	Library	Last Used
DSPPTYPES	*PGM	RPGLE	Display Product	File Read By Program	XAN4CDEM	00/00/00
OE001	*PGM	RPG	Order Entry	File Read By Program	XAN4CDEM	00/00/00
OE002	*PGM	RPG	Order Enquiry	File Read By Program	XAN4CDEM	00/00/00
OE003	*PGM	RPG	Product Enquiry	File Read By Program	XAN4CDEM	00/00/00
OE006	*PGM	RPG	Print Invoices	File Read By Program	XAN4CDEM	00/00/00
OE008	*PGM	RPG	Order Entry	File Read By Program	XAN4CDEM	00/00/00
ZAUDPTYPES	*PGM	RPGLE	Audit PTYPES file	File Read By Program	XAN4CDEM	00/00/00

**Object Where Used for QLETSRC**

Object	Type	Attribute	Text	Usage	Library	Last Used
FAXSHT	*PGM	CLP	Immediate Faxshot	File Updated By Program	XAN4CDEM	00/00/00
FXS1C	*PGM	CLP	Special Faxshot	File Updated By Program	XAN4CDEM	00/00/00
WKCUSL	*PGM	CLP	Customer Letter	File Updated By Program	XAN4CDEM	00/00/00
WKCUS8E	*PGM	RPG	Customer Release Letter	File Read/Written To By Program	XAN4CDEM	00/00/00
WKCUS8P	*PGM	RPG	Customer Enquiry Letter	File Read By Program	XAN4CDEM	00/00/00
WKSECF6B	*PGM	CLP	Fax CPU Details	File Read By Program	XAN4CDEM	00/00/00
WKSECF6B3	*PGM	CLP	Send Distribution Fax	File Read By Program	XAN4CDEM	00/00/00

**Object Where Used for OE001**

Object	Type	Attribute	Text	Usage	Library	Last Used
OEMENU	*PGM	CLP	Order Entry Menu	Calling Program	XAN4CDEM	00/00/00
OE008	*PGM	RPG	Order Entry	Calling Program	XAN4CDEM	00/00/00

***Object Where Used for OE001DF***

Previously documnted

**Object Where Used for CUSTSL3**

Object	Type	Attribute	Text	Usage	Library	Last Used
CUSTS	*FILE	PF	Purchases	Physical File	XAN4CDEM	00/00/00
OE001	*PGM	RPG	Order Entry	File Updated/Written To By Program	XAN4CDEM	00/00/00
OE002	*PGM	RPG	Order Enquiry	File Read By Program	XAN4CDEM	00/00/00
OE004	*PGM	RPG	Customer Enquiry/Maintenance	File Updated/Written To By Program	XAN4CDEM	00/00/00
OE006	*PGM	RPG	Print Invoices	File Read By Program	XAN4CDEM	00/00/00
OE008	*PGM	RPG	Order Entry	File Updated/Written To By Program	XAN4CDEM	00/00/00
TSTPGM171	*PGM	RPGLE	To tst SQL statements	File Read By Program	XAN4CDEM	00/00/00
ZAUDCUSF	*PGM	RPGLE	Audit CUSF file	File Read By Program	XAN4CDEM	00/00/00

## ***Object Where Used for PTYPES***

[Previously documnted](#)

**Object Where Used for CUSLET**

Object	Type	Attribute	Text	Usage	Library	Last Used
OE001	*PGM	RPG	Order Entry	Calling Program	XAN4CDEM	00/00/00

**Object Where Used for CUSLET1**

Object	Type	Attribute	Text	Usage	Library	Last Used
CUSLET	*PGM	CLP	Customer Letter - Stage 1	Calling Program	XAN4CDEM	00/00/00



**Object Where Used for LETN1**

Object	Type	Attribute	Text	Usage	Library	Last Used
CLET	*PGM	CLP	Build Customer Letter	Calling Program	XAN4CDEM	00/00/00
CLETN	*PGM	CLP	Print Customer Letter	Calling Program	XAN4CDEM	00/00/00
CPDM	*PGM	CLP	List Correspondence	Calling Program	XAN4CDEM	00/00/00
CUSLET1	*PGM	CLP	Customer Letter - Stage 2	Calling Program	XAN4CDEM	00/00/00

**Object Where Used for CUSFL3**

Object	Type	Attribute	Text	Usage	Library	Last Used
CONUPD0	*PGM	RPGLE	Revert Back Customer Info	File Updated By Program	XAN4CDEM	00/00/00
CONUPD1	*PGM	RPGLE	Update Customer Info - Version 1	File Updated By Program	XAN4CDEM	00/00/00
CONUPD2	*PGM	RPGLE	Update Customer Info - Version 2	File Updated By Program	XAN4CDEM	00/00/00
CUSCPY	*PGM	RPG	Customer Copy	File Read By Program	XAN4CDEM	00/00/00
CUSF	*FILE	PF	Sites	Physical File	XAN4CDEM	00/00/00
CUSFMAINT	*PGM	RPGLE	Customer Site Maintenance	File Updated By Program	XAN4CDEM	00/00/00
CUSFMOLD	*PGM	RPGLE	Customer Site Maintenance	File Updated By Program	XAN4CDEM	00/00/00
CUSFSEL	*PGM	RPGLE	Customer Site Selection	File Read By Program	XAN4CDEM	00/00/00
CUSLETSQ	*PGM	RPG	Update Letter Sequence	File Updated By Program	XAN4CDEM	00/00/00
CUSREAD	*PGM	RPGLE	Test Sequential Read options	File Read By Program	XAN4CDEM	00/00/00
CUSREADDEL	*PGM	RPGLE	TEST SEQUENTIAL READ OPTIONS	File Read By Program	XAN4CDEM	00/00/00
CUSRGZ	*PGM	RPG	Reorganize Customer File	File Updated By Program	XAN4CDEM	00/00/00
CUSTMNTJR	*PGM	RPGLE	Customer Detail Maintenance	File Read By Program	XAN4CDEM	00/00/00
CUSTMNT1	*PGM	RPGLE	Customer Detail Maintenance	File Read By Program	XAN4CDEM	00/00/00
CUSTMNT1_0	*PGM	RPGLE	Customer Detail Maintenance	File Read By Program	XAN4CDEM	00/00/00
CUSTMNT1_1	*PGM	RPGLE	Customer Detail Maintenance	File Read By Program	XAN4CDEM	00/00/00
CUSTMNT1_2	*PGM	RPGLE	Customer Detail Maintenance	File Read By Program	XAN4CDEM	00/00/00
FAXERR1	*PGM	RPG	Faxshot Errors Part 1.	File Updated By Program	XAN4CDEM	00/00/00

## System Document for XAN4CDXA - Application Area YYORDER

FAXERR2	*PGM	RPG	Faxshot Errors Part 2.	File Updated By Program	XAN4CDEM	00/00/00
GCNTAC1	*PGM	RPG	Generate Prospect Record	File Read By Program	XAN4CDEM	00/00/00
GCUST1	*PGM	RPG	Generate Purchase Record	File Read By Program	XAN4CDEM	00/00/00
GETDCOD	*PGM	RPGLE	Find Customer Distributor Code	File Read By Program	XAN4CDEM	00/00/00
GETDCODS	*MODULE	RPGLE	Find Customer Distributor Code (SRVPGM)	File Read By Module	XAN4CDEM	00/00/00
GETDCODS	*SRVPGM	RPGLE		File Read By Service	XAN4CDEM	00/00/00
LETN1	*PGM	RPG	Letter Prefix Generation	File Read By Program	XAN4CDEM	00/00/00
OE002	*PGM	RPG	Order Enquiry	File Read By Program	XAN4CDEM	00/00/00
OE006	*PGM	RPG	Print Invoices	File Read By Program	XAN4CDEM	00/00/00
OE008	*PGM	RPG	Order Entry	File Read By Program	XAN4CDEM	00/00/00
SECFO	*PGM	RPG	Reorganize Codes File	File Read/Written To By Program	XAN4CDEM	00/00/00
SECFOCLP	*PGM	CLP	Security Report	File Read By Program	XAN4CDEM	00/00/00
WCUSTP	*PGM	RPGLE	Print Customer Detail	File Read By Program	XAN4CDEM	00/00/00
WKCUS8E	*PGM	RPG	Customer Release Letter	File Read By Program	XAN4CDEM	00/00/00
WKCUS8EF	*PGM	RPG	Find Fax Number	File Read By Program	XAN4CDEM	00/00/00
WKSECF6	*PGM	RPG	Generate CPU Letter	File Read By Program	XAN4CDEM	00/00/00
WWCONHDR	*PGM	RPGLE	Work with Orders	File Read By Program	XAN4CDEM	00/00/00
WWCUSF	*PGM	RPGLE	Work with Customer Sites	File Updated/Written To By Program/Delete Operation	XAN4CDEM	00/00/00
WWCUSTS	*PGM	RPGLE	Work with Customers	File Read By Program	XAN4CDEM	00/00/00
WWCUSTSARR	*PGM	RPGLE	Work with Customers	File Read By Program	XAN4CDEM	00/00/00

## System Document for XAN4CDXA - Application Area YYORDER

WWCUSTS_0	*PGM	RPGLE	Work with Customers	File Read By Program	XAN4CDEM	00/00/00
WWCUSTS_1	*PGM	RPGLE	Work with Customers	File Read By Program	XAN4CDEM	00/00/00
WWCUSTS2	*PGM	RPGLE	Work with Customers	File Read By Program	XAN4CDEM	00/00/00
WWTRNHST	*PGM	RPGLE	Work with transaction history	File Read By Program	XAN4CDEM	00/00/00
ZBCONHDR	*PGM	CBL	Work with Orders - Cobol vers.	File Read By Program	XAN4CDEM	00/00/00
ZBCUSFMNT	*PGM	CBL	Customer Site Maintenance	File Updated/Written To By Program	XAN4CDEM	00/00/00
ZBCUSTS	*PGM	CBL	Work with customer - Cobol vers.	File Read By Program	XAN4CDEM	00/00/00
ZBTRNHST	*PGM	CBL	Work with transaction history	File Read By Program	XAN4CDEM	00/00/00

**Object Where Used for WKCUSL**

Object	Type	Attribute	Text	Usage	Library	Last Used
CLET	*PGM	CLP	Build Customer Letter	Calling Program	XAN4CDEM	00/00/00
CUSLET1	*PGM	CLP	Customer Letter - Stage 2	Calling Program	XAN4CDEM	00/00/00

***Object Where Used for QLETSRC***

[Previously documnted](#)

**Object Where Used for CUSLETSQ**

Object	Type	Attribute	Text	Usage	Library	Last Used
WKCUSL	*PGM	CLP	Customer Letter	Calling Program	XAN4CDEM	00/00/00
WKSECF6B	*PGM	CLP	Fax CPU Details	Calling Program	XAN4CDEM	00/00/00

**Object Where Used for WKCUS8EF**

Object	Type	Attribute	Text	Usage	Library	Last Used
CUSMNU	*PGM	CLP	Customer Menu	Calling Program	XAN4CDEM	00/00/00
FAXSHT1	*PGM	RPG	Generate Fax Shot	Calling Program	XAN4CDEM	00/00/00
WKCUSL	*PGM	CLP	Customer Letter	Calling Program	XAN4CDEM	00/00/00
WKSECF6	*PGM	RPG	Generate CPU Letter	Calling Program	XAN4CDEM	00/00/00



**Object Where Used for WKCUS8E**

Object	Type	Attribute	Text	Usage	Library	Last Used
CUSMNU	*PGM	CLP	Customer Menu	Calling Program	XAN4CDEM	00/00/00
FAXSHT1	*PGM	RPG	Generate Fax Shot	Calling Program	XAN4CDEM	00/00/00
WKCUSL	*PGM	CLP	Customer Letter	Calling Program	XAN4CDEM	00/00/00

**Object Where Used for WKCUS8P**

Object	Type	Attribute	Text	Usage	Library	Last Used
CUSMNU	*PGM	CLP	Customer Menu	Calling Program	XAN4CDEM	00/00/00
FAXSHT1	*PGM	RPG	Generate Fax Shot	Calling Program	XAN4CDEM	00/00/00
WKCUSL	*PGM	CLP	Customer Letter	Calling Program	XAN4CDEM	00/00/00
WKSECF6B	*PGM	CLP	Fax CPU Details	Calling Program	XAN4CDEM	00/00/00
WKSECF6B3	*PGM	CLP	Send Distribution Fax	Calling Program	XAN4CDEM	00/00/00

## ***Data Flow Diagram (Normal) for CUSF***

### **Annotation for CUSF**

Bob take in a little more detail please. This is an update.

[https://docs.google.com/document/d/1-CRK4AnYqlvj3BP5Zb3GggFLKVIUwF8m3iHTJvsYDf0/edit?usp=share\\_link](https://docs.google.com/document/d/1-CRK4AnYqlvj3BP5Zb3GggFLKVIUwF8m3iHTJvsYDf0/edit?usp=share_link)

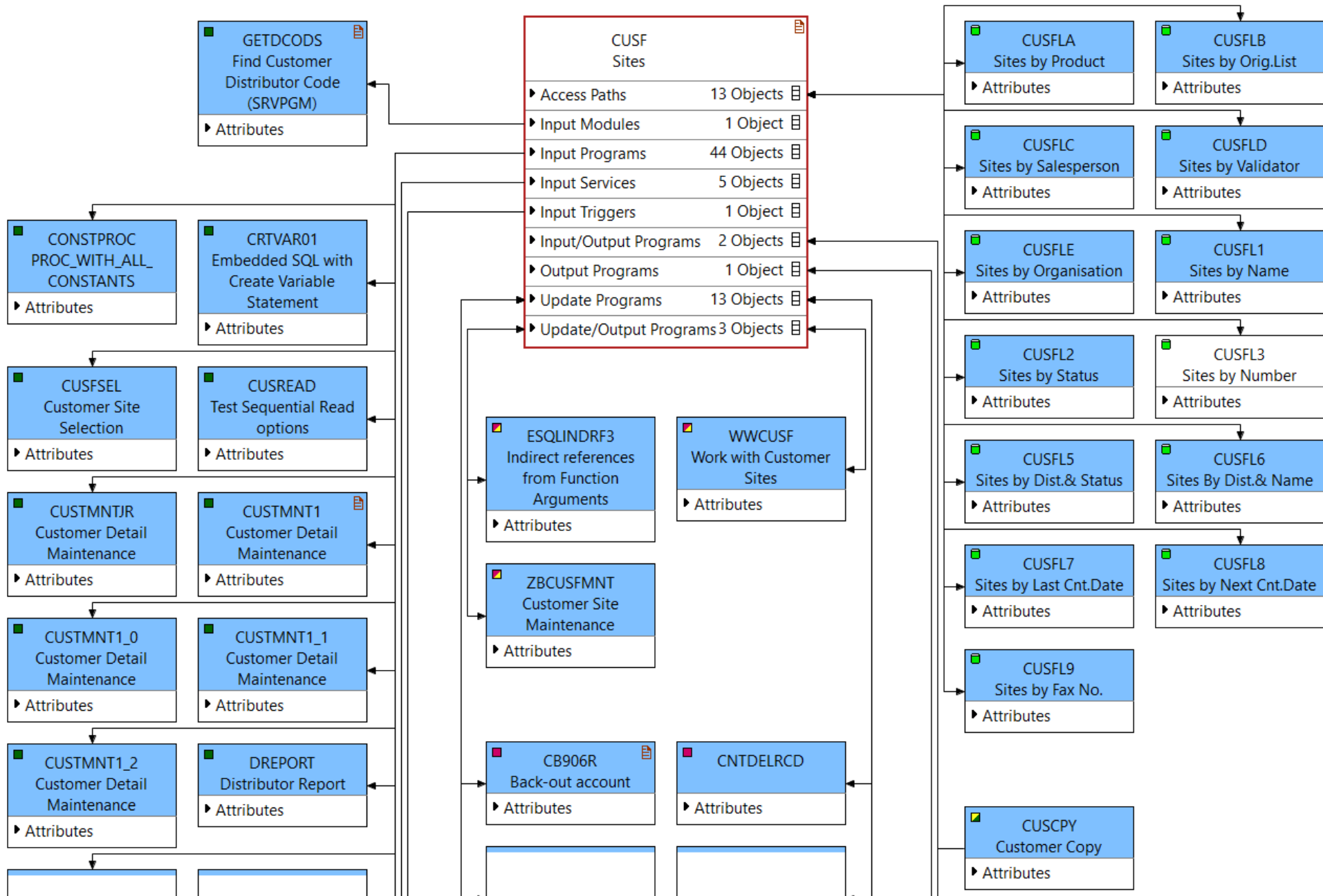



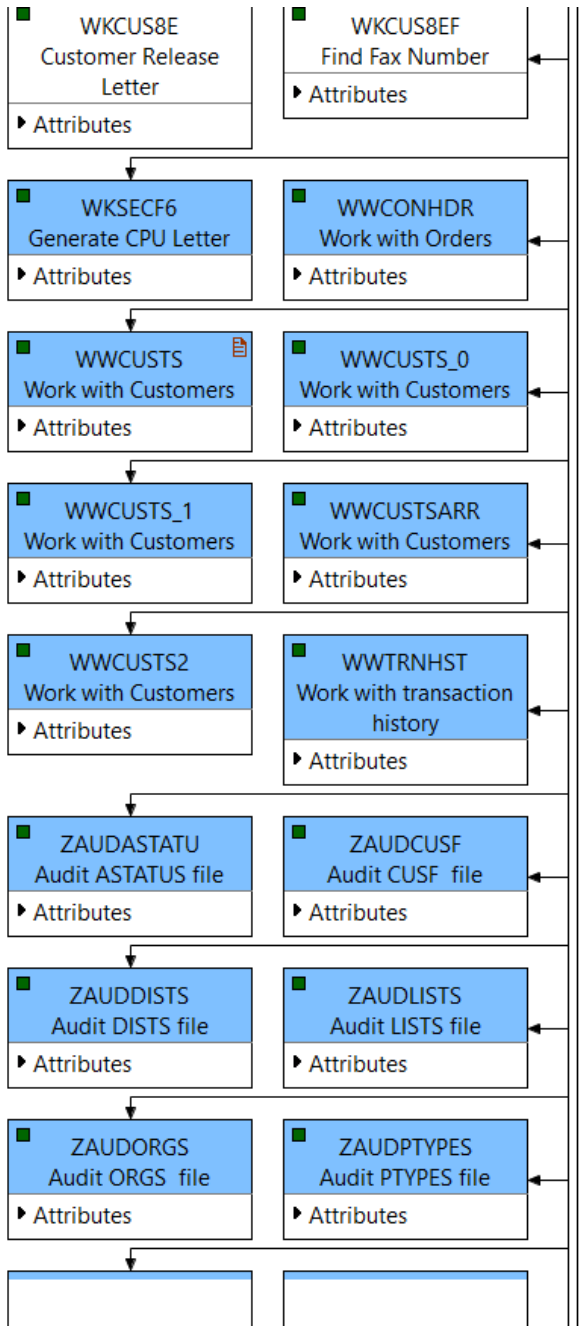

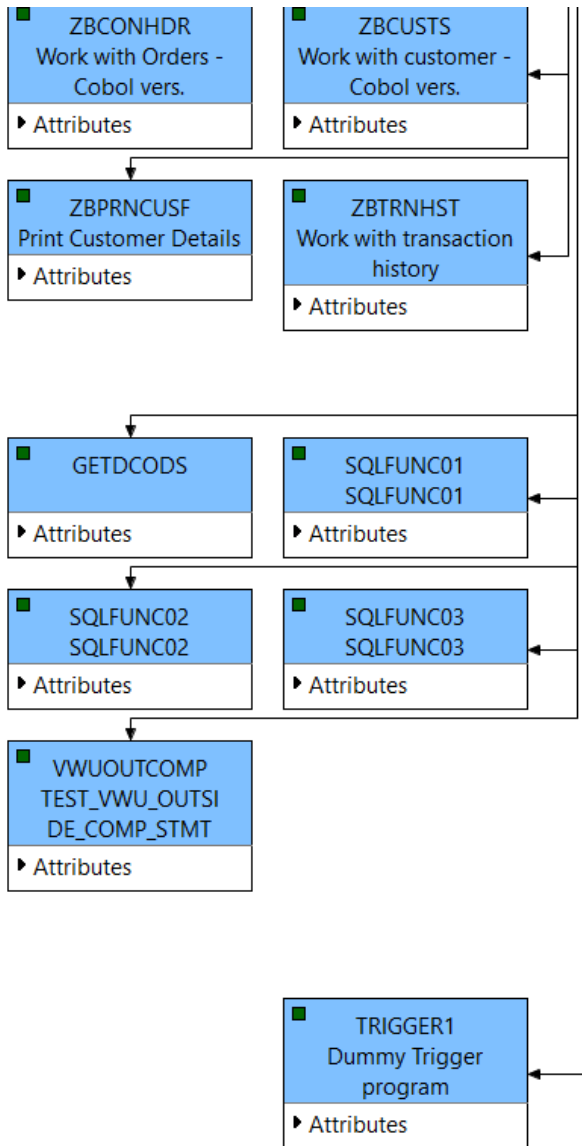

### Data Flow Diagram (Normal) for CUSTS

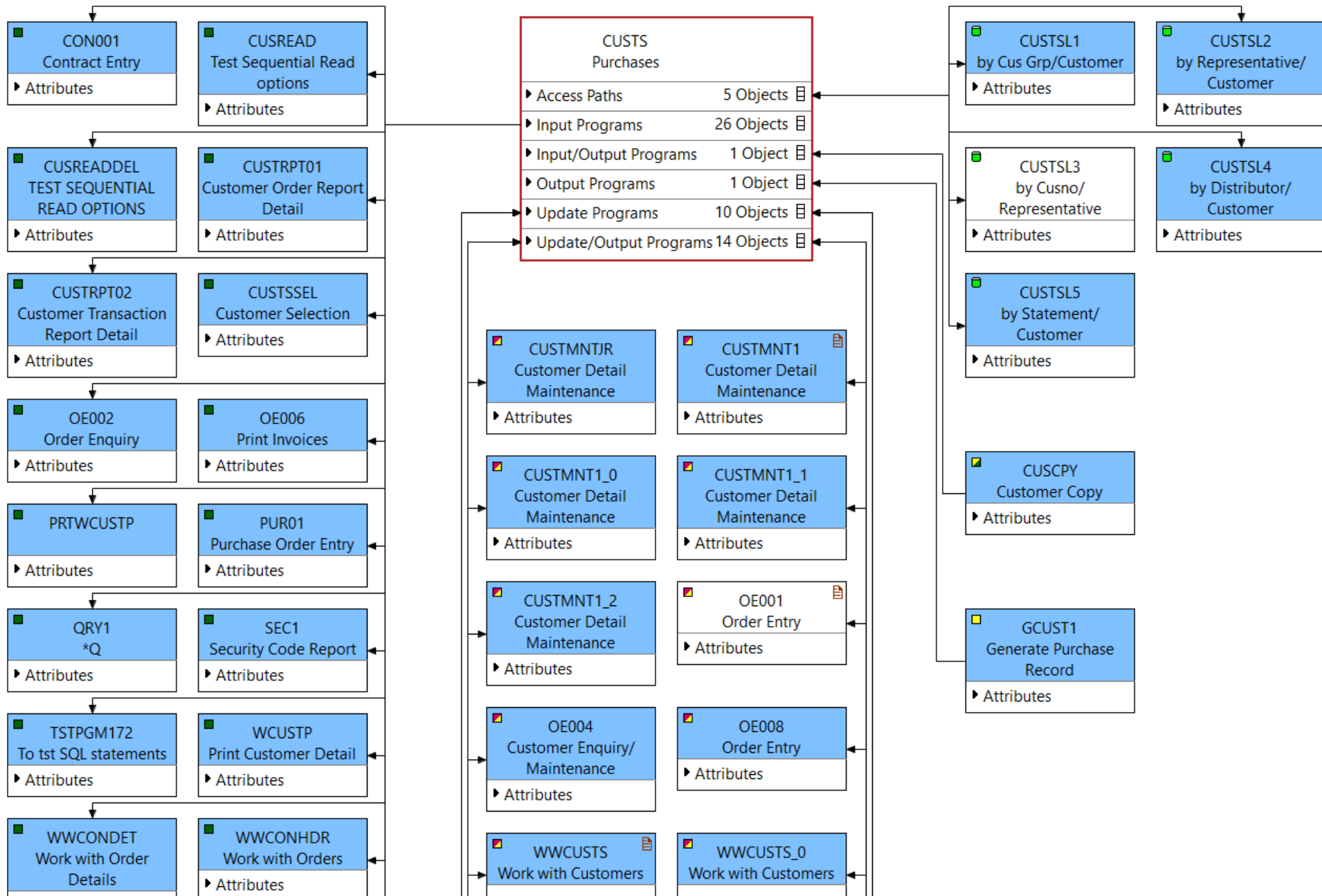



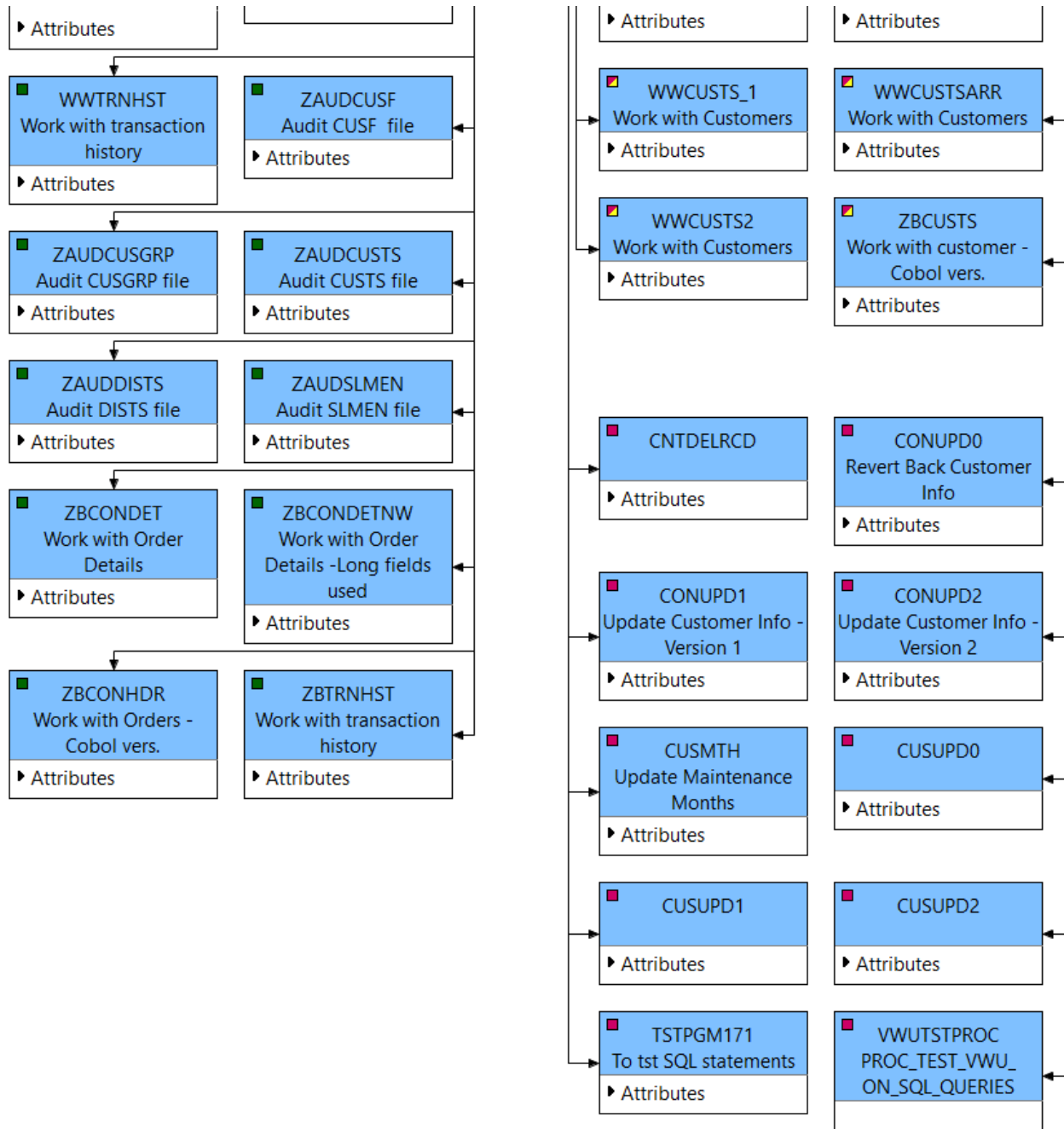

└──────────┘ ▶ Attributes

### Data Flow Diagram (Normal) for PTYPES

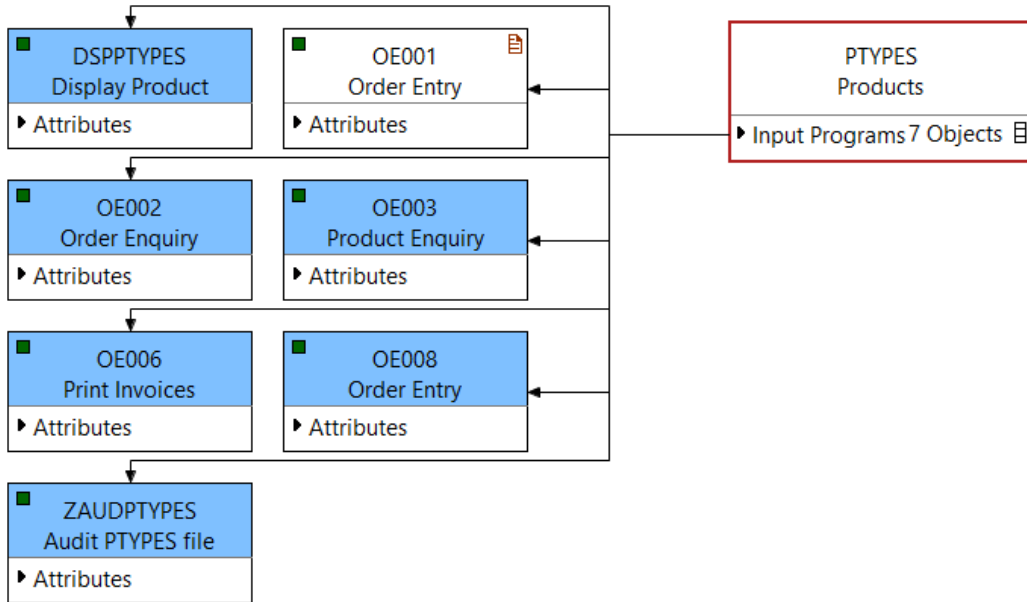

## ***Data Flow Diagram (Normal) for QLETSRC***

### **Annotation for QLETSRC**

XZXZ .VZ.V.,CV.XCV-CV-,CV

non cancellare ques

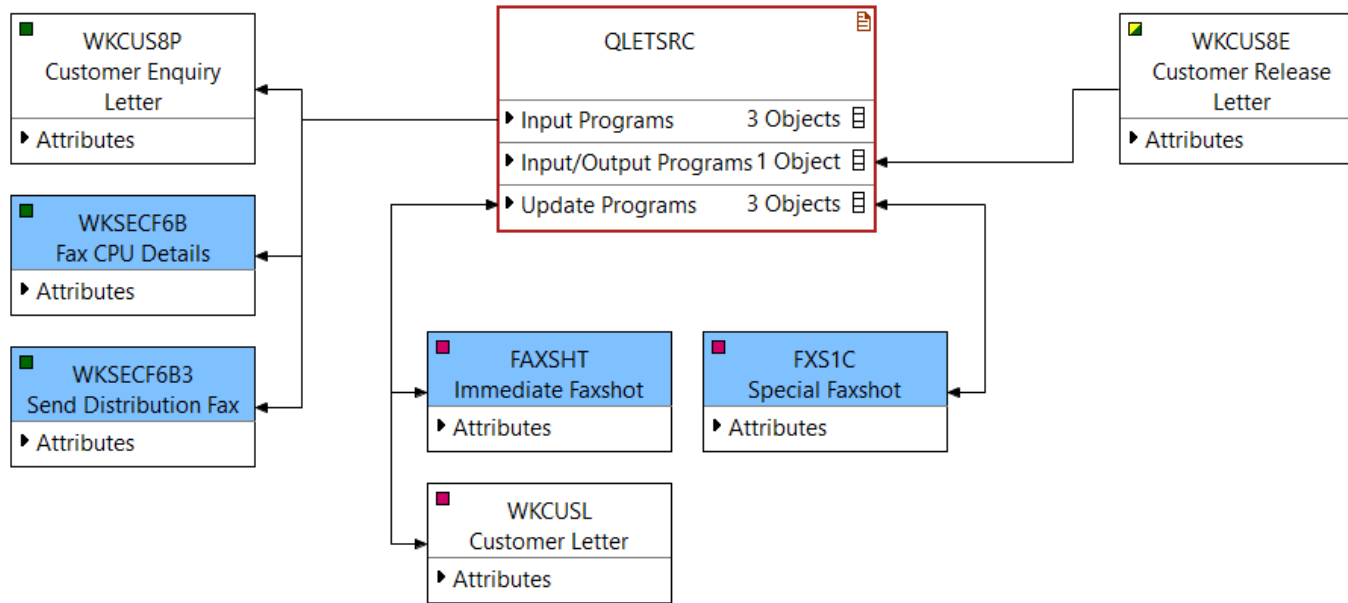

## ***Data Flow Diagram (Normal) for OE001***

**Annotation for OE001**

### **Sub-Heading**

At this point, we need to do something.

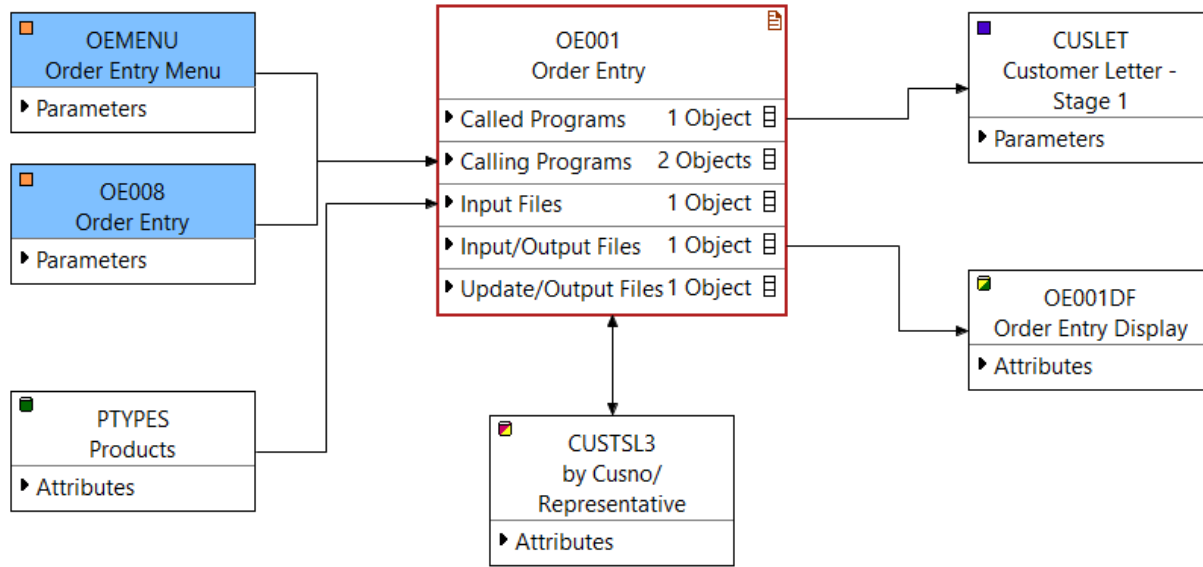

**Data Flow Diagram (Normal) for CUSTSL3**

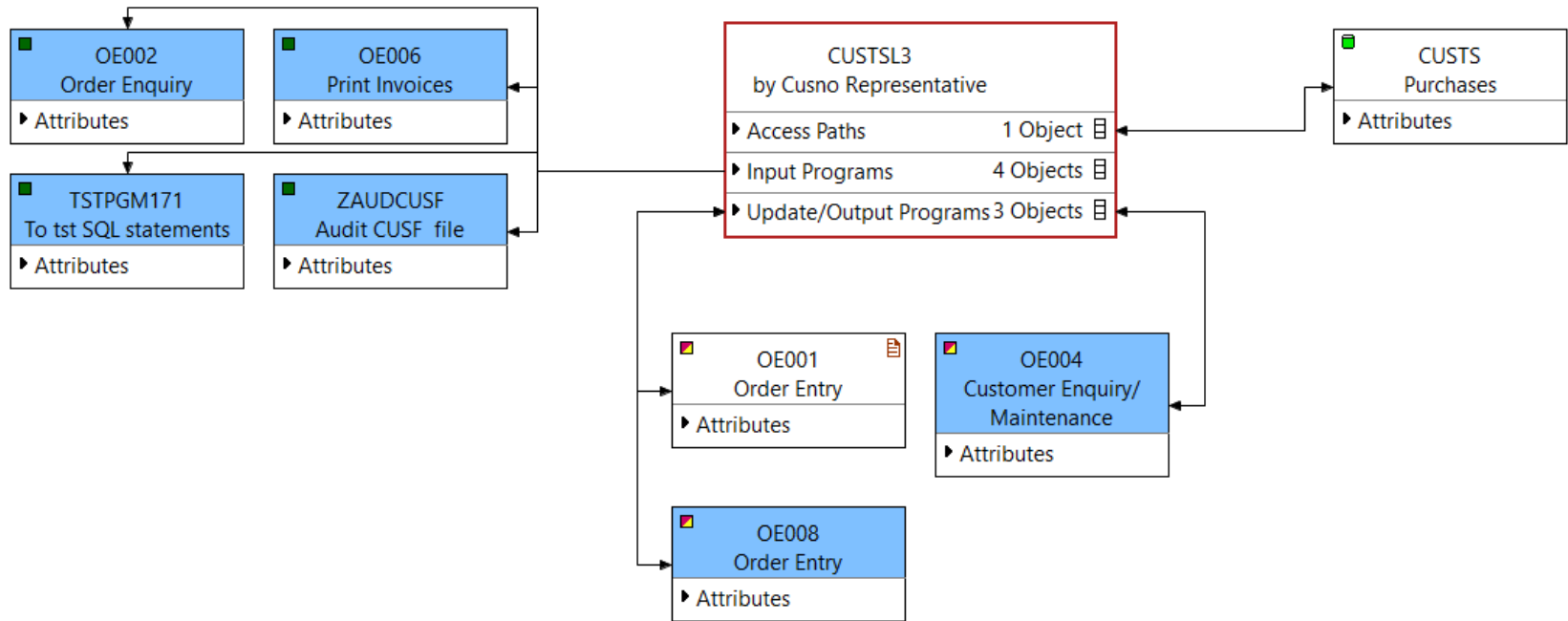



## ***Data Flow Diagram (Normal) for PTYPES***

[Previously documnted](#)

### Data Flow Diagram (Normal) for CUSLET

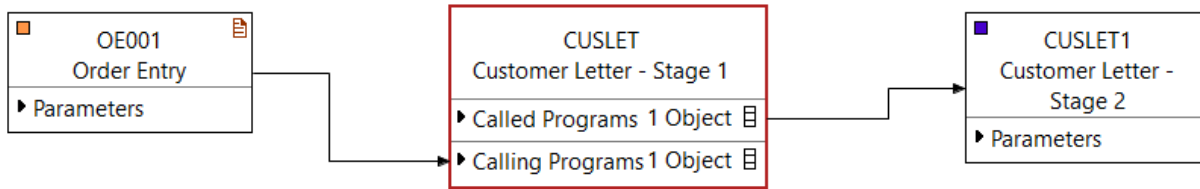

### Data Flow Diagram (Normal) for CUSLET1

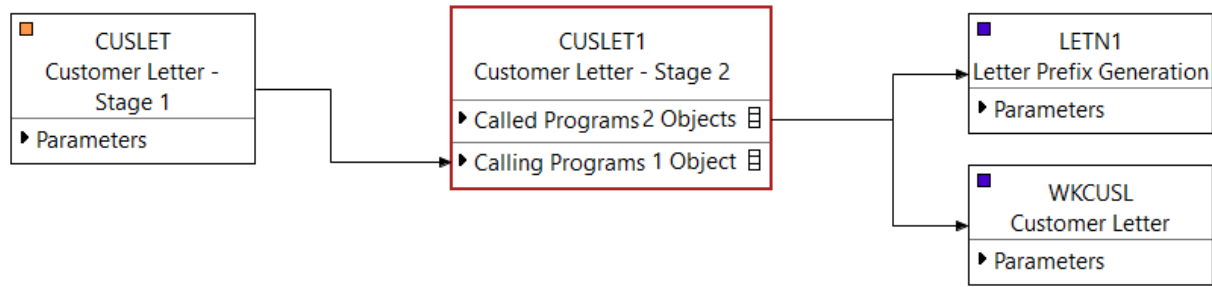

### Data Flow Diagram (Normal) for LETN1

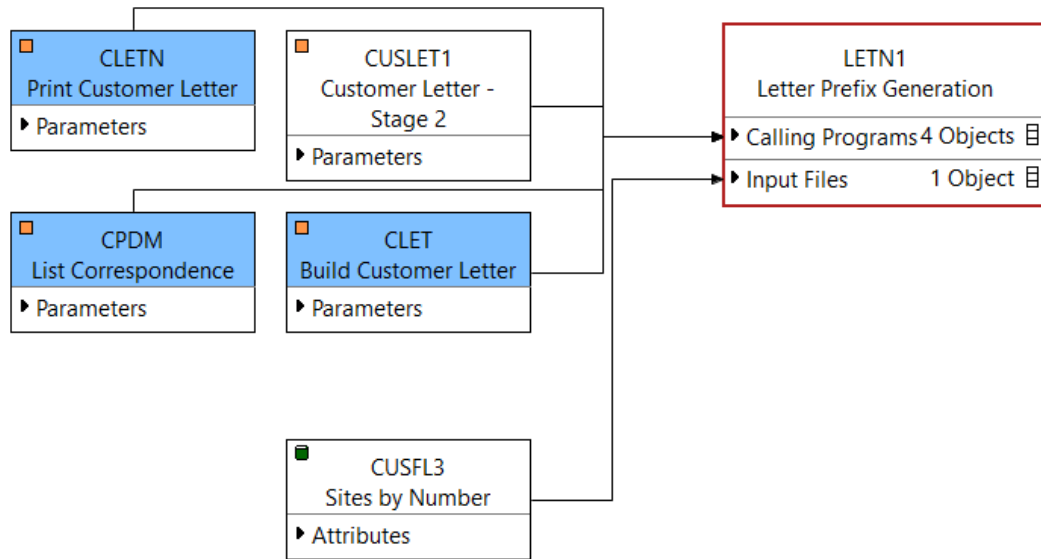

### Data Flow Diagram (Normal) for CUSFL3

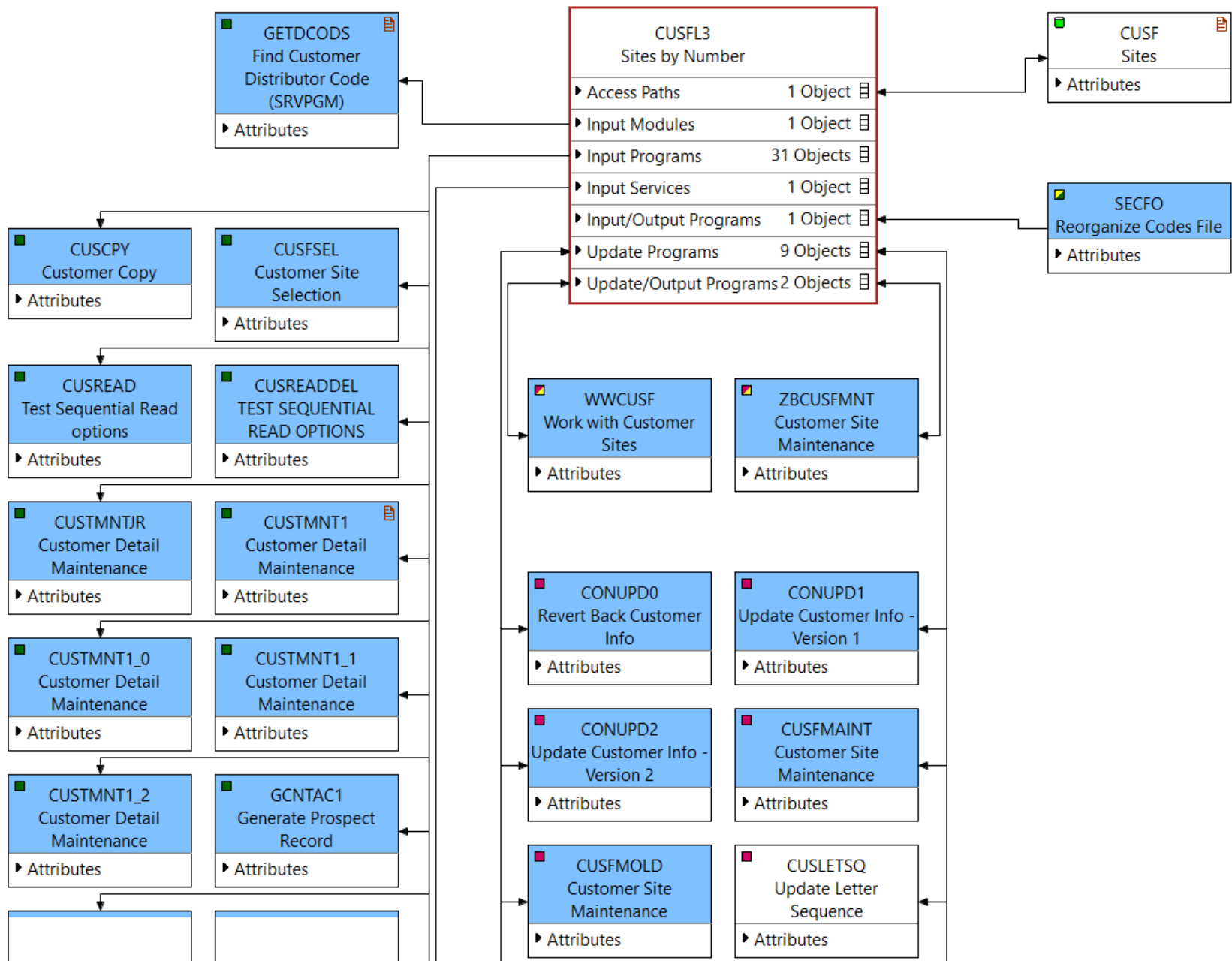

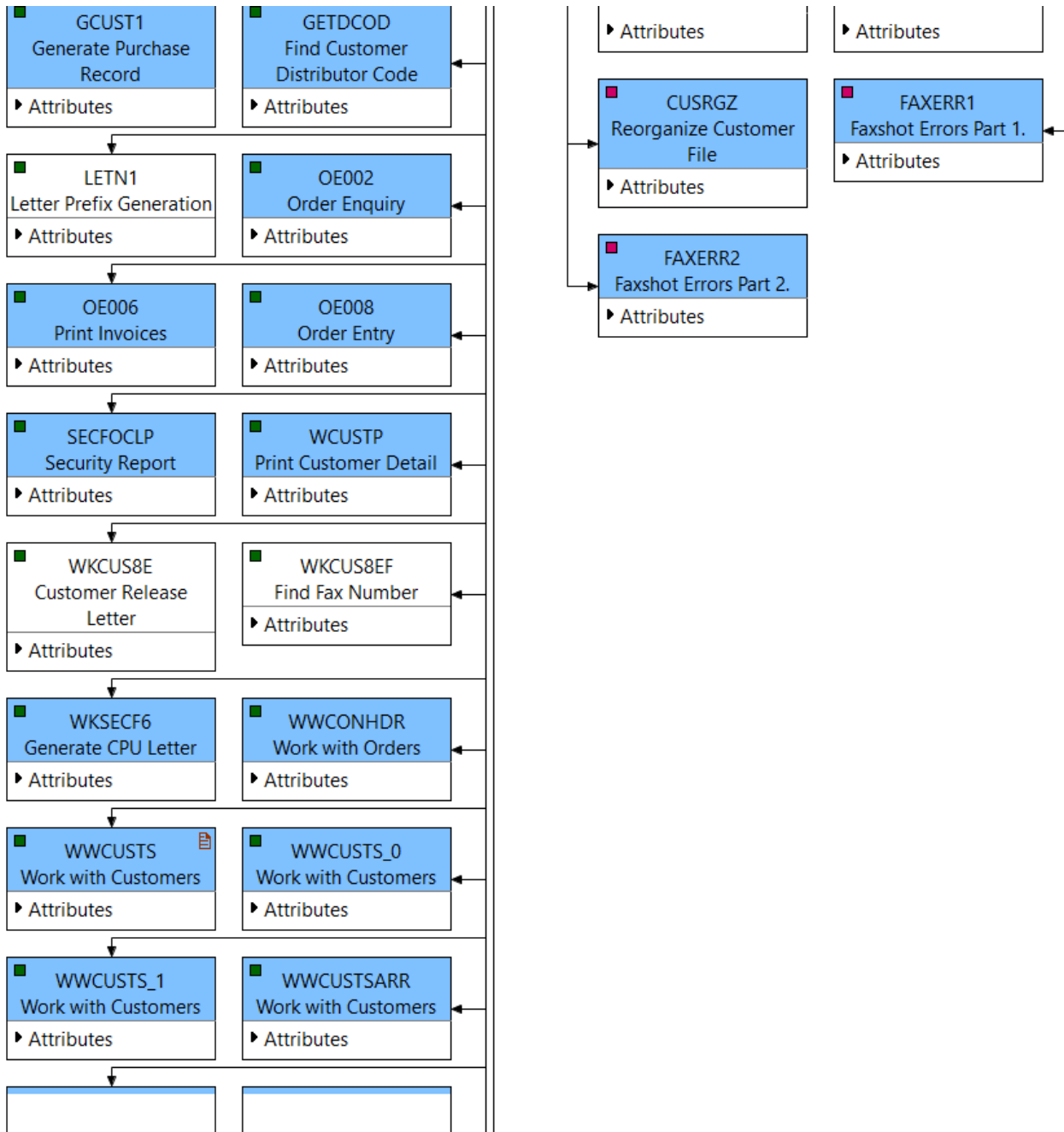

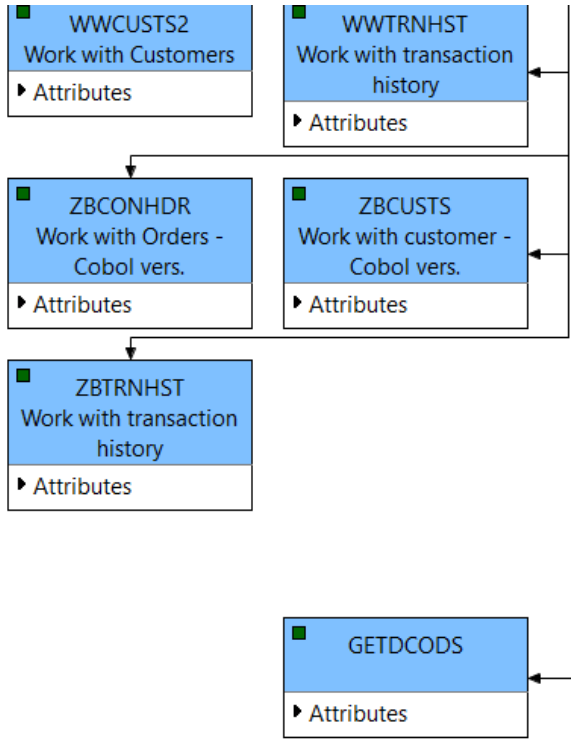

**Data Flow Diagram (Normal) for WKCUSL**

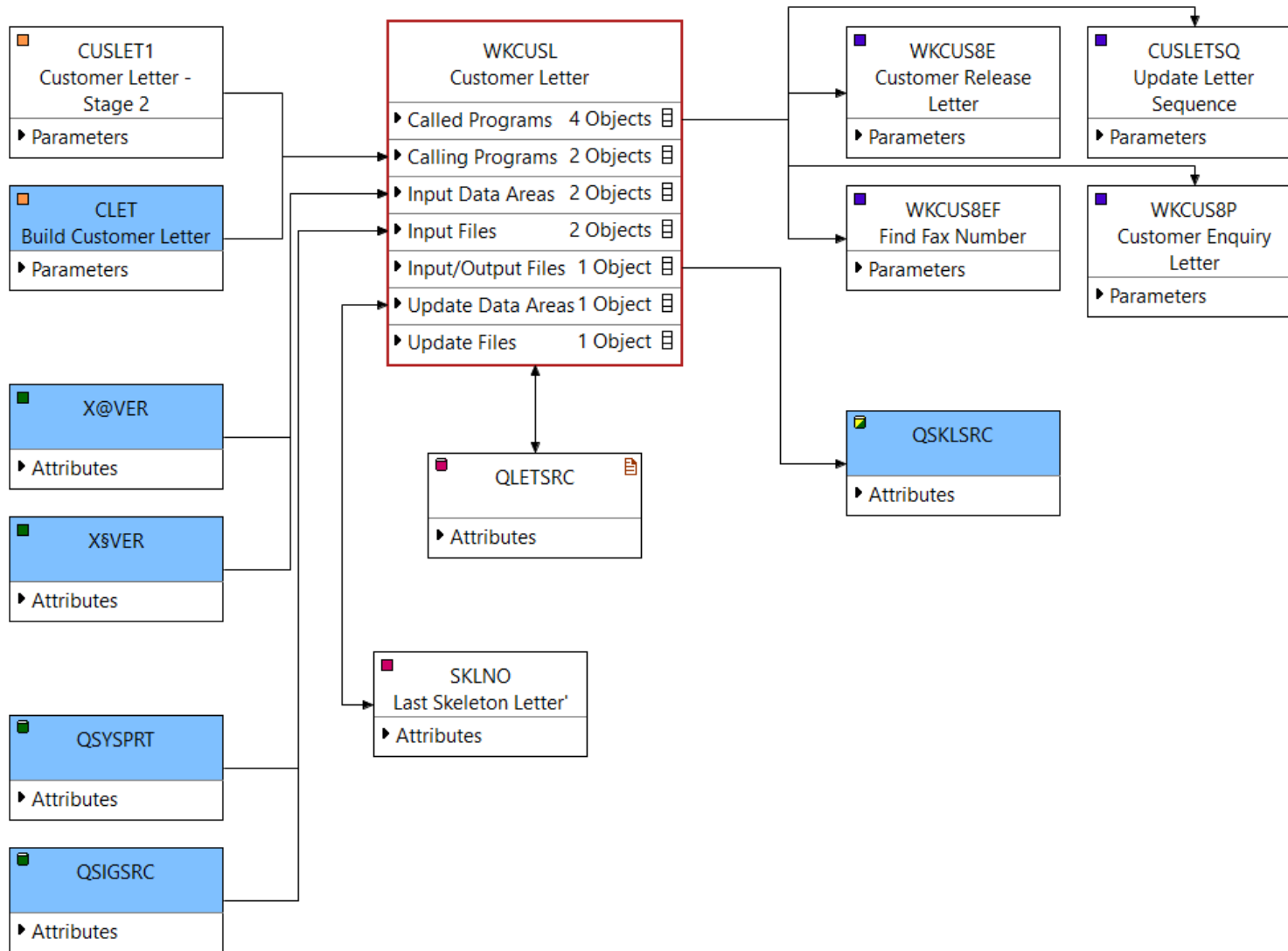



***Data Flow Diagram (Normal) for QLETSRC***

[Previously documnted](#)

### Data Flow Diagram (Normal) for CUSLETSQ

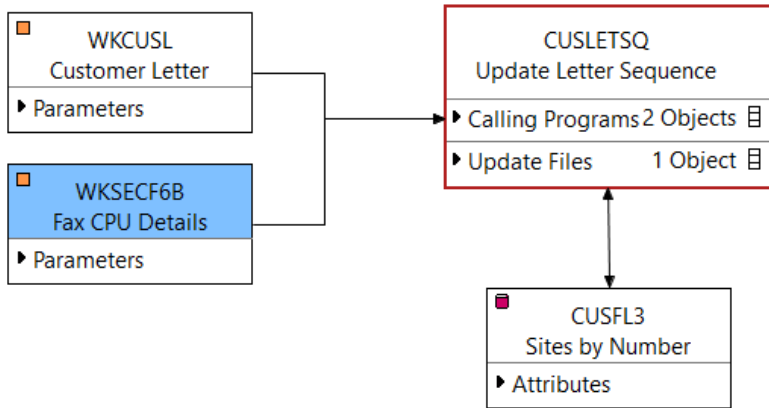

### Data Flow Diagram (Normal) for WKCUS8EF

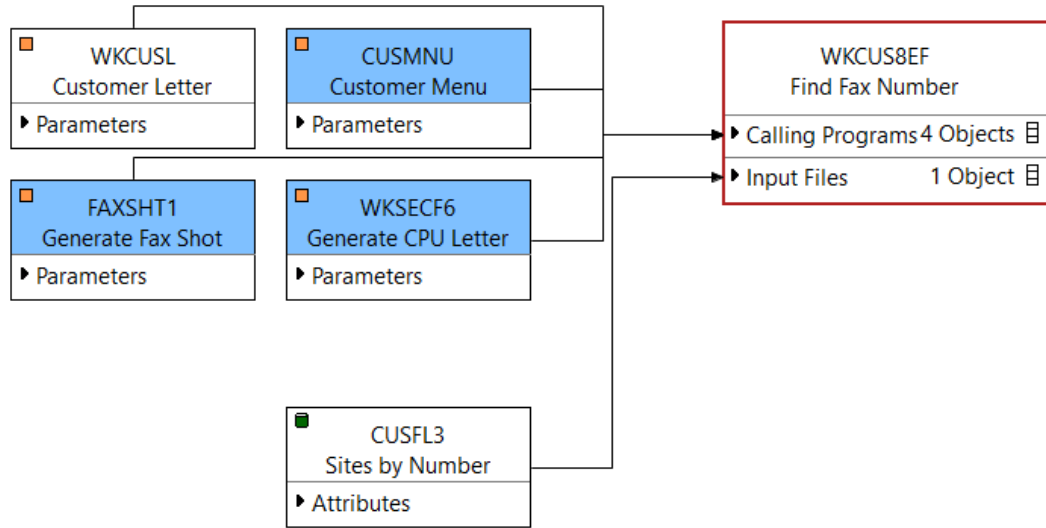

### Data Flow Diagram (Normal) for WKCUS8E

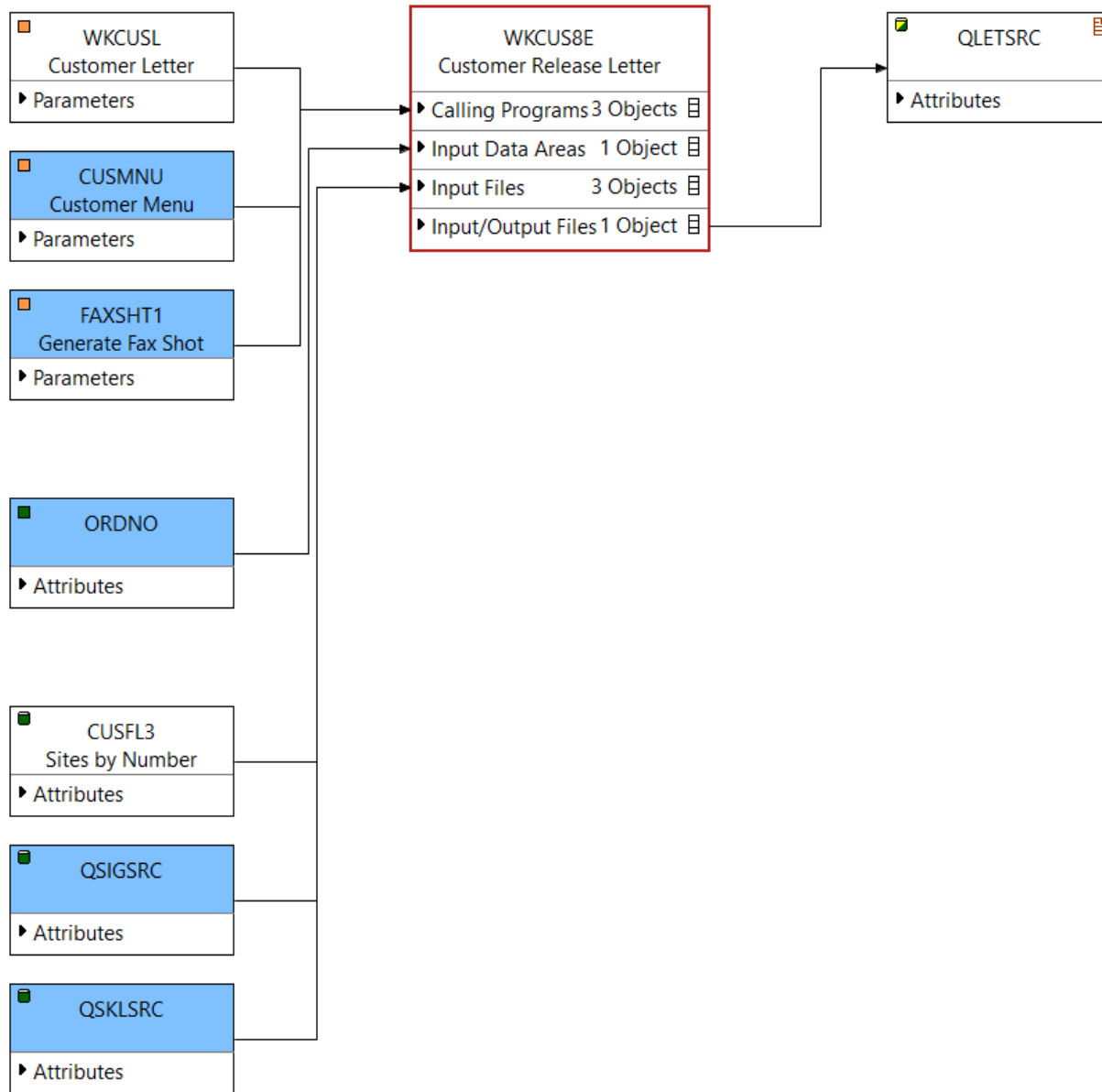

**Data Flow Diagram (Normal) for WKCUS8P**

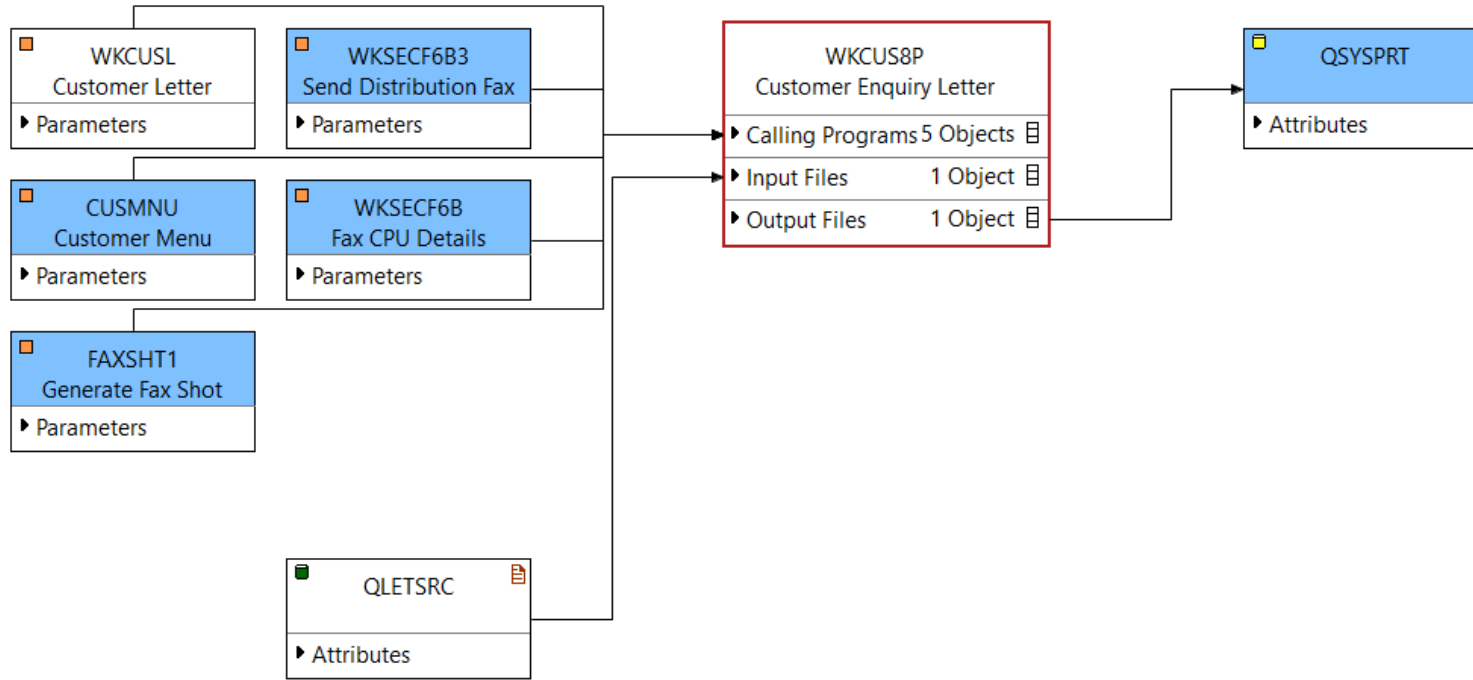

## ***Structure Chart Diagram (Normal) for OE001***

**Annotation for OE001**

### **Sub-Heading**

At this point, we need to do something.

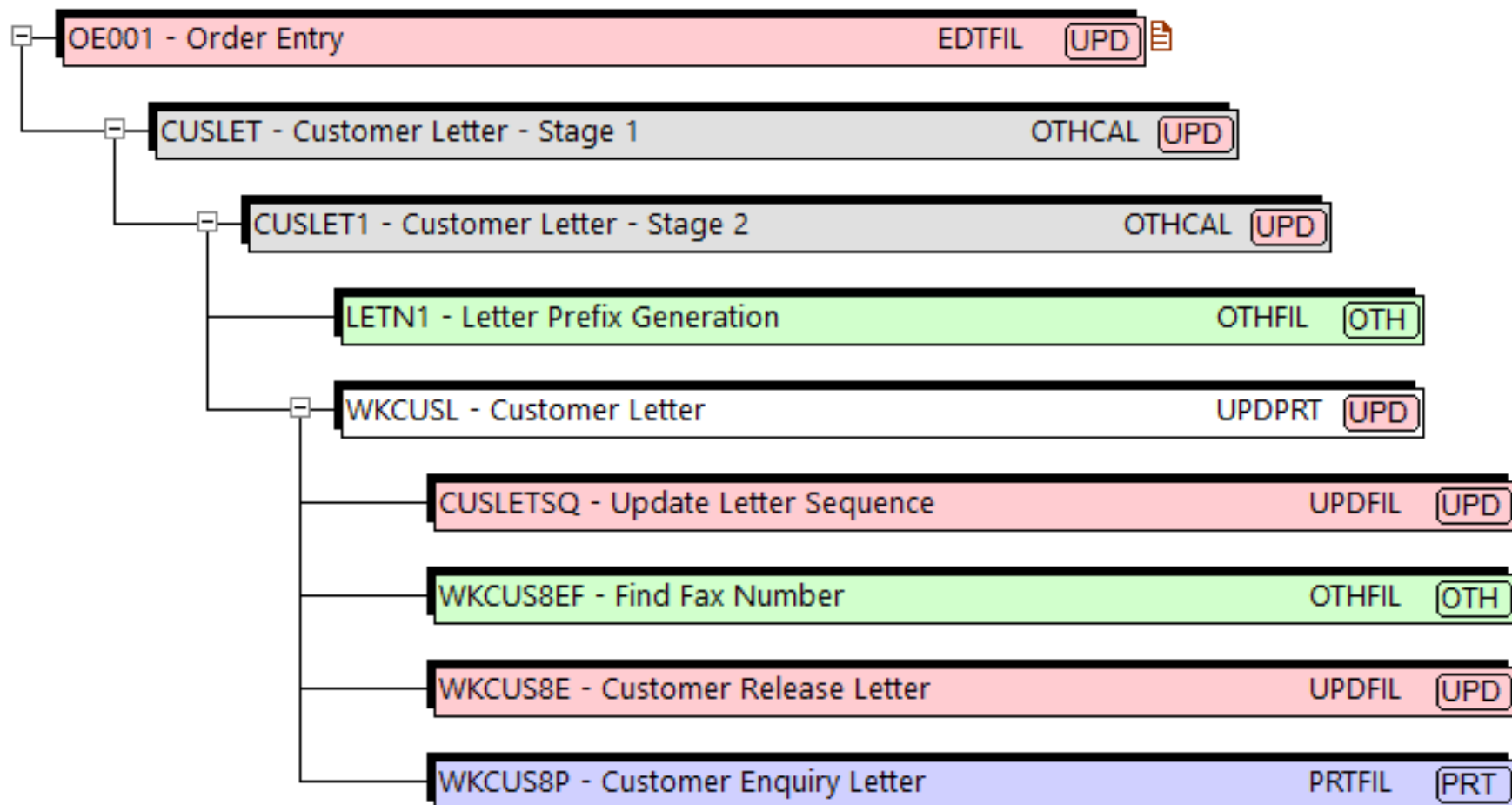

**Structure Chart Diagram (Normal) for CUSLET**

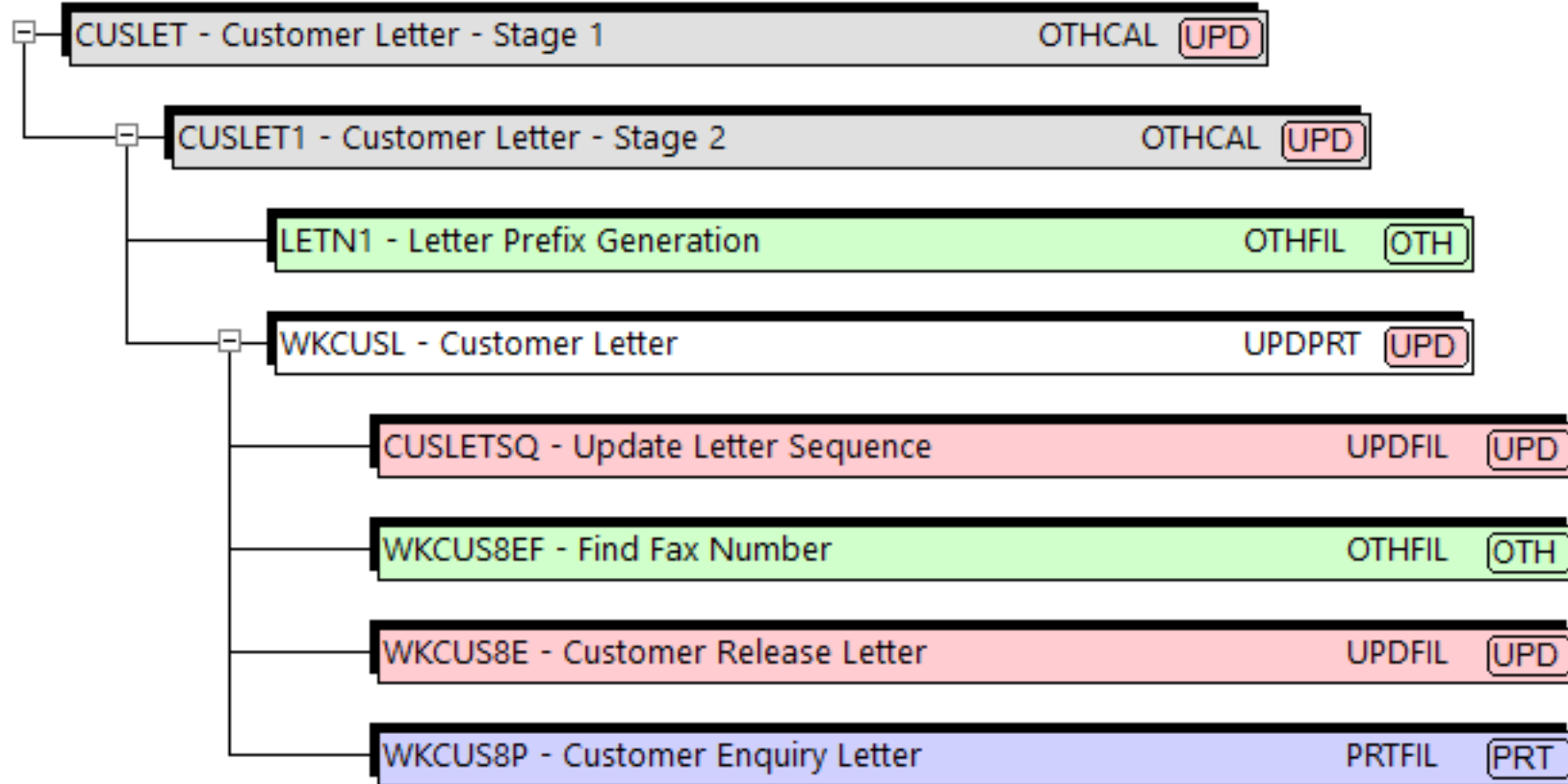



**Structure Chart Diagram (Normal) for CUSLET1**

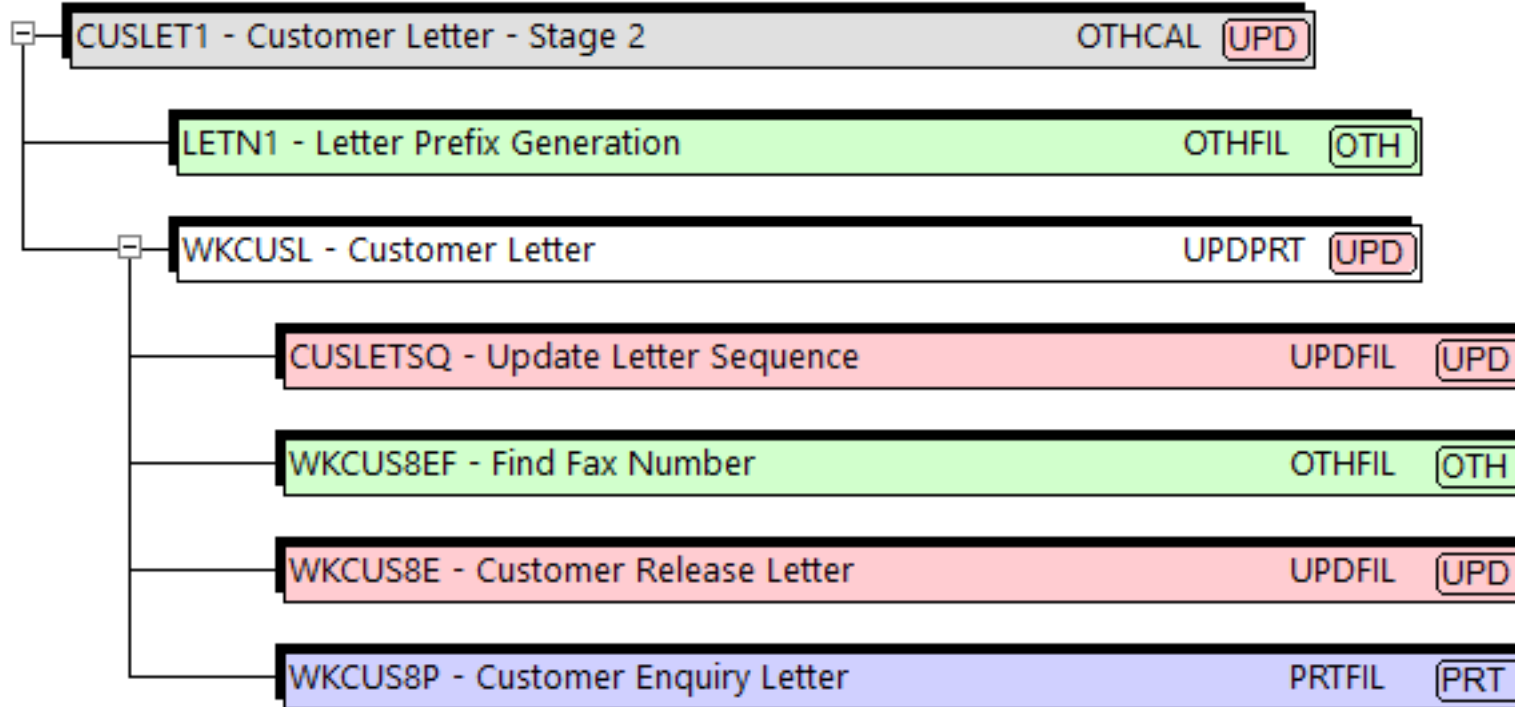

**Structure Chart Diagram (Normal) for LETN1**



**Structure Chart Diagram (Normal) for WKCUSL**

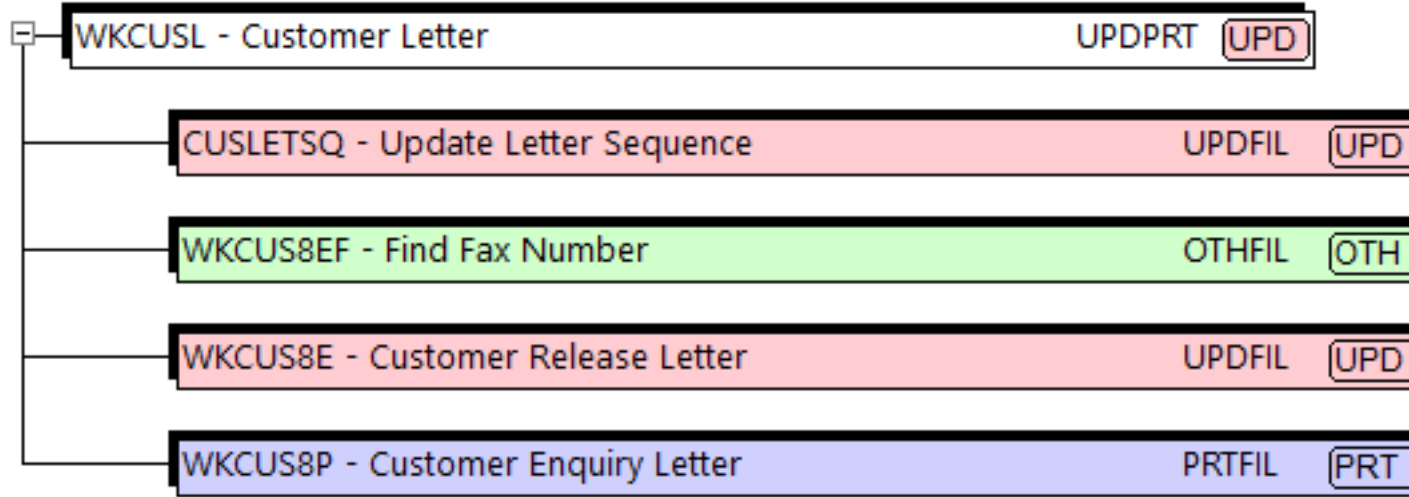

**Structure Chart Diagram (Normal) for CUSLETSQ**



**Structure Chart Diagram (Normal) for WKCUS8EF**



**Structure Chart Diagram (Normal) for WKCUS8E**

WKCUS8E - Customer Release Letter

UPDFIL

UPD

**Structure Chart Diagram (Normal) for WKCUS8P**

WKCUS8P - Customer Enquiry Letter      PRTFIL      PRT

**Screen Design for OE001**

**1. Screen Design for OESFLC (OE00101G)**

X-Analysis	Print display file	Fresche Solutions
XAPRTDSPF		10:10:22 20 Sep 2023
	Display_file_:_OE001DF	Page_0001
0000000000	ORDER ENTRY	99:99:99 99/99/99
Order No: 99999	Customer	00000000000000000000000000000000
Customer No: 99999	Address	00000000000000000000000000000000
		00000000000000000000000000000000
		00000000
Order Lines:		
Line	Product	Description
66666	99999	00000000000000000000000000000000
		99999
		00000000000000000000000000000000
		Record_format(s)
<OESFLC>	<OESFL>	<OETRL>



## 1.1. Field List for Format OESFLC (OE00101G)

Label	Line	Column	Field	Key Type	File	Attribute	Type	Length	Decimal Position
	1	2	@@PGM		WorkField	Output	A	10	0
Line	1	2	OLLNNO		WorkField	Output	P	5	0
Product	1	9	OLPROD		WorkField	Both	P	5	0
Description	1	20	PRDESC		WorkField	Output	A	30	0
Quantity	1	61	OLQTY		WorkField	Both	P	5	0
Order No:	3	13	CUSNO		CUSTS	Both	P	5	0
Customer	3	35	CSNAME		WorkField	Output	A	34	0
Customer No:	4	16	DSCSNO		WorkField	Both	P	5	0
Address	4	35	CSADD1		WorkField	Output	A	34	0
	5	35	CSADD2		WorkField	Output	A	34	0
	6	35	CSADD3		WorkField	Output	A	34	0
	7	35	CSPSCD		WorkField	Output	A	8	0

## Report Layout for WKCUS8P

### 1. Report Layout for WKCUS8P (RPG)

X-Analysis	Databorough
Ltd	
_____Printer File :	
QSYSPRT_____	
XX	
_____Record	
Format(s)_____	
<PRTDET>	

**Business Rules for OE001**

Rule No.	Annotation	Rule	Rule Details	Field	File
00001		Prospect_No not found on Purchases	<pre>// Get Customer Record Read data CUSTSR(by Representative/Customer) using CUSNO(CUSNO(Prospect_No)) IF Not Found(Purchases)   CSNAME(Customer Name) = *BLANKS   CSADD1(Address) = *BLANKS   CSADD2 = *BLANKS   CSADD3 = *BLANKS   CSPSCD = *BLANKS END</pre>	CUSNO	CUSTS
00002		Prospect_No found on Purchases	<pre>// 1. Order Header Read data CUSTSR(by Representative/Customer) using CUSNO(CUSNO(Prospect_No)) IF Found(Purchases)   DSCSNO(Customer_No) = CUSNO(CUSNO(Prospect_No))   UPDATE CUSTSR(by Representative/Customer) ELSE   CUSNO(CUSNO(Prospect_No)) = CUSNO(CUSNO(Prospect_No))</pre>	CUSNO	CUSTS

			WRITE CUSTSR(by Representative/Customer) END		
00003		Prospect_No found on Purchases	// Read data CUSTSR(by Representative/Customer) using CUSNO(CUSNO(Prospect_No)) IF Found(Purchases) UPDATE CUSTSR(by Representative/Customer) ELSE WRITE CUSTSR(by Representative/Customer) END	CUSNO	CUSTS
00004		Code <> 0	// If successfully retrieved IF Found(OE001DF(Order Entry Display)) // // If data entered IF PRPCDE(PRPCDE(Code)) <> *ZEROS // // Validate Product & Get Product Description Read data RPRODS(Products) using PRPCDE(PRPCDE(Code)) // UPDATE OESFL(Order Entry	PRPCDE	PTYPES

			Display) // // End: If data entered END // // End: If successfully retrieved END		
--	--	--	--	--	--

## ***Business Rules for OE001DF***

Previously documnted

## ***Business Rules for PTYPES***

Previously documnted

**Business Rules for LETN1**

Rule No.	Annotation	Rule	Rule Details	Field	File
00001		Doc_Prfl = blank	<pre>IF PREFIX(PREFIX(Doc_Prfl)) = *BLANK   PREFIX(PREFIX(Doc_Prfl)) =   CUSNO(CUSNO(Cus_No))   // *          MOVE CUSNAM   PRENAM END</pre>	PREFIX	CUSF



## ***Business Rules for QLETSRC***

[Previously documnted](#)

**Business Rules for CUSLETSQ**

Rule No.	Annotation	Rule	Rule Details	Field	File
00001		Cus_No found on Sites	<pre>Read data Sites using CUSNO(CUSNO(Cus_No)) LLETSQ(LLETSQ&gt;Last_Let)) = LETNR // **          MOVE LETNR TRSNOQ IF Found(Sites)   UPDATE RCUSF(Sites) END</pre>	CUSNO	CUSF

**Business Rules for WKCUS8EF**

Rule No.	Annotation	Rule	Rule Details	Field	File
00001		Fax_No = blank	<pre>// Terminate if there is no fax number on the database. IF FAXNO(FAXNO(Fax_No)) = *BLANK GOTO FINISH END</pre>	FAXNO	CUSF
00002		Fax_No(@X) >= '0' and Fax_No(@X) <= '9'	<pre>IF FAX(@X) &gt;= '0' AND FAX(@X) &lt;= '9' @F = @F + 1 @WA(@F) = FAX(@X) END</pre>	FAXNO	CUSF
00003		Phone = blank	<pre>// If there is no telephone number on the database then terminate // with the current fax number on the database. IF TELNO(TELNO(Phone)) = *BLANK GOTO FINISH END</pre>	TELNO	CUSF
00004		Phone(@X) >= '0' and Phone(@X) <= '9'	<pre>IF @TEL(@X) &gt;= '0' AND @TEL(@X) &lt;= '9' @T = @T + 1 @WA(@T) = @TEL(@X)</pre>	TELNO	CUSF

			END		
00005		Phone(@T) >= '0' and Phone(@T) <= '9'	IF @TEL(@T) >= '0' AND @TEL(@T) <= '9' @T = @T + 1 @F = @F + 1 @WA(@W) = @FAX(@F) ELSE @WA(@W) = '-' EXECUTE (\$NEXT) // * LEAVESR END	TELNO	CUSF
00006		@T <= 17 and Phone(@T) <> 'X' and Phone(@T) <> 'x'	IF @T <= 17 AND @TEL(@T) <> 'X' AND @TEL(@T) <> 'x'	TELNO	CUSF
00007		Phone(@T) < '0' or Phone(@T) > '9'	IF @TEL(@T) < '0' OR @TEL(@T) > '9' @NEXT = 'N' END END	TELNO	CUSF

**Business Rules for WKCUS8E**

Rule No.	Annotation	Rule	Rule Details	Field	File
00001		Cus_No found on Sites	<pre> Read data Sites using CUSNO(CUSNO(Cus_No)) IF Found(Sites) // ***** ***** // // TYPE PARAMETER DETERMINES THE TYPE OF LETTER // PROCESSED: // P: PROFORMA LETTER // S: SECURITY LETTER // BLANK: ALL THE OTHER LETTER TYPES. // // ***** ***** // SELECT WHEN TYPE = 'P' EXECUTE (PROFOR) WHEN TYPE = 'S'                     </pre>	CUSNO	CUSF

			EXECUTE (SECURT) WHEN TYPE = 'M' EXECUTE (MEMO) OTHER EXECUTE (LETTER) END		
00002		Company <> blank	IF SRCDTA <> *BLANKS SRCSEQ = SRCSEQ + 1 WRITE @LETSRC TXT = *BLANKS END	CNAME	CUSF
00003		Company <> blank	IF SRCDTA <> *BLANKS SRCSEQ = SRCSEQ + 1 WRITE @LETSRC TXT = *BLANKS END	CNAME	CUSF
00004		Company <> blank	IF SRCDTA <> *BLANKS SRCSEQ = SRCSEQ + 1 WRITE @LETSRC TXT = *BLANKS END	CNAME	CUSF
00005		Company <> blank	IF SRCDTA <> *BLANKS SRCSEQ = SRCSEQ + 1 WRITE @LETSRC TXT = *BLANKS END	CNAME	CUSF
00006		Company <> blank	IF SRCDTA <> *BLANKS	CNAME	CUSF

			<pre> SRCSEQ = SRCSEQ + 1 WRITE @LETSRC TXT = *BLANKS END </pre>		
00007		Company <> blank	<pre> IF SRCDTA &lt;&gt; *BLANKS SRCSEQ = SRCSEQ + 1 WRITE @LETSRC TXT = *BLANKS END </pre>	CNAME	CUSF
00008		Company <> blank	<pre> IF SRCDTA &lt;&gt; *BLANKS SRCSEQ = SRCSEQ + 1 WRITE @LETSRC TXT = *BLANKS END </pre>	CNAME	CUSF
00009		Company <> blank	<pre> IF SRCDTA &lt;&gt; *BLANKS SRCSEQ = SRCSEQ + 1 WRITE @LETSRC TXT = *BLANKS END </pre>	CNAME	CUSF
00010		Company <> blank	<pre> IF SRCDTA &lt;&gt; *BLANKS SRCSEQ = SRCSEQ + 1 WRITE @LETSRC TXT = *BLANKS END </pre>	CNAME	CUSF
00011		Company <> blank	<pre> IF SRCDTA &lt;&gt; *BLANKS SRCSEQ = SRCSEQ + 1 WRITE @LETSRC </pre>	CNAME	CUSF

			TXT = *BLANKS END		
00012		Company(X) = blank	IF TXT(X) = *BLANK TXT(X) = '-' END	CNAME	CUSF



**Source for CUSF**

<i>Seq No</i>	<i>*</i>	<i>1</i>	<i>2</i>	<i>3</i>	<i>4</i>	<i>5</i>	<i>6</i>	<i>7</i>	<i>8</i>	<i>9</i>	<i>*</i>	<i>Date Changed</i>
0001.00	A		R	RCUSF								90/03/26
0002.00	A			CNAME	34A			TEXT('Company')				91/07/31
0003.00	A			DSDCDE	2A			TEXT('Distributor')				05/08/01
0004.00	A			STATUS	1A			TEXT('Status')				95/12/12
0005.00	A							COLHDG('Sts')				95/12/12
0006.00	A			TELNO	17A			TEXT('Phone')				95/12/12
0007.00	A			EXTN	6A			TEXT('Extn.')				00/00/00
0008.00	A			LCTDAT	6S 0			TEXT('Last Contact Date')				95/12/11
0009.00	A							COLHDG('Last Cnt' 'Date')				95/12/13
0010.00	A							EDTCDE(Y)				91/07/31
0011.00	A			APDATE	6S 0			TEXT('Next Contact Date')				95/12/11
0012.00	A							COLHDG('Next Cnt' 'Date')				95/12/13
0013.00	A							EDTCDE(Y)				00/00/00
0014.00	A			USERNM	34A			TEXT('Contact')				95/12/12
0015.00	A			SALUT	34A			TEXT('Salutation')				00/00/00
0016.00	A			JTITILE	34A			TEXT('Job Title')				00/00/00
0017.00	A			FAXNO	15A			TEXT('Fax. No.')				98/11/18
0018.00	A			EMAIL	40A			TEXT('Email')				02/10/24
0019.00	A			WEBSIT	40A			TEXT('Website')				02/10/24
0020.00	A			ADD1	34A			TEXT('Address 1')				95/12/12
0021.00	A			ADD2	34A			TEXT('Address 2')				95/12/12
0022.00	A			ADD3	34A			TEXT('Address 3')				95/12/12
0023.00	A			ADD4	34A			TEXT('Address 4')				95/12/12
0024.00	A			CNTRY	25A			TEXT('Country')				95/12/12
0025.00	A			PSCD	8A			TEXT('Post Code')				95/12/12
0026.00	A			CUSNO	5P 0			TEXT('Cus. No.')				90/04/12
0027.00	A							COLHDG('Cus.' 'No.')				95/12/12
0028.00	A			CMMNT1	40A			TEXT('Comment Line 1')				02/10/24
0029.00	A			CMMNT2	40A			TEXT('Comment Line 2')				02/10/24
0030.00	A			CMMNT3	40A			TEXT('Comment Line 3')				02/10/24

System Document for XAN4CDXA - Application Area YYORDER

0031.00	A	DOCRC	3A	TEXT('Docn.sent')	95/12/11
0032.00	A			COLHDG('Doc.' 'Sent')	95/12/12
0033.00	A	DOC2	3A	TEXT('Lit. Sent 2.')	95/12/11
0034.00	A			COLHDG('Doc.' 'Sent')	95/12/12
0035.00	A	DOC3	3A	TEXT('Lit. Sent 3.')	95/12/11
0036.00	A			COLHDG('Doc.' 'Sent')	95/12/12
0037.00	A	DOC4	3A	TEXT('Lit. Sent 4.')	95/12/11
0038.00	A			COLHDG('Doc.' 'Sent')	95/12/12
0039.00	A	DOC5	3A	TEXT('Lit. Sent 5.')	95/12/11
0040.00	A			COLHDG('Doc.' 'Sent')	95/12/12
0041.00	A	DOC6	3A	TEXT('Lit. Sent 6.')	95/12/11
0042.00	A			COLHDG('Doc.' 'Sent')	95/12/12
0043.00	A	OLDMCH	2A	TEXT('Machine')	95/12/12
0044.00	A			COLHDG('Mch')	95/12/12
0045.00	A	PRPCDE	2A	TEXT('Product Code')	05/08/01
0046.00	A	LSLCDE	2A	TEXT('Orig. List Code')	05/08/01
0047.00	A			COLHDG('Orig' 'List')	95/12/12
0048.00	A	PREFIX	5A	TEXT('Doc.Prefix:')	94/05/20
0049.00	A			COLHDG('Doc.' 'Prf.')	95/12/12
0050.00	A	LLETSQ	3P 0	TEXT('Last letter no.')	95/12/12
0051.00	A			COLHDG('Last' 'Let.')	95/12/12
0052.00	* new:				00/00/00
0053.00	A	SPREQ	40A	TEXT('Special Requirements')	02/10/24
0054.00	A			COLHDG('Spec' 'Req.')	00/00/00
0055.00	A	RISC	1A	TEXT('Cisc/Risc/Both')	00/00/00
0056.00	A	ALTTEL	17A	TEXT('Alt.Tel.No.1')	00/00/00
0057.00	A	ALTTL2	17A	TEXT('Alt.Tel.No.2')	00/00/00
0058.00	A	SINIT	3A	TEXT('Salesperson')	00/00/00
0059.00	A	VERYFD	1A	TEXT('Verified?')	00/00/00
0060.00	A	VINIT	3A	TEXT('Verified By')	00/00/00
0061.00	A	VFDATE	6S 0	TEXT('Verification Date')	00/00/00
0062.00	A			EDTCDE(Y)	00/00/00
0063.00	A	CRTNAM	10A	TEXT('Created By:')	00/00/00
0064.00	A	CRTDAT	6S 0	TEXT('Creation Date')	00/00/00

0065.00	A			EDTCDE(Y)	00/00/00
0066.00	A	UPDNAM	10A	TEXT('Updated By:')	00/00/00
0067.00	A	UPDDAT	6S 0	TEXT('Update Date')	00/00/00
0068.00	A			EDTCDE(Y)	00/00/00
0069.00	A	ORG	5P 0	TEXT('Organisation')	00/00/00

**Source for CUSFL3**

<i>Seq No</i>	<i>*</i>	<i>1</i>	<i>2</i>	<i>3</i>	<i>4</i>	<i>5</i>	<i>6</i>	<i>7</i>	<i>8</i>	<i>9</i>	<i>*</i>	<i>Date Changed</i>
0001.00	A					UNIQUE						90/07/27
0002.00	A		R	RCUSF		PFILE(CUSF)						90/07/27
0003.00	A		K	CUSNO								00/00/00
0003.01												16/11/21

**Source for CUSTS**

Seq No	*	1	2	3	4	5	6	7	8	9	*	Date Changed
0001.00		A*										10/03/18
0002.00		A				UNIQUE						00/00/00
0003.00		A	R	CUSTSR								01/05/07
0004.00		A		XWBCCD	11A	TEXT('Customer')						01/05/07
0005.00		A				COLHDG('Customer' 'Number')						10/03/18
0006.00		A		XWG4TX	40A	TEXT('Name')						01/05/07
0006.01		A				COLHDG('Name')						10/03/18
0007.00		A		XWB2CD	11A	TEXT('Statement Account')						01/05/07
0007.01		A				COLHDG('Statement' 'Account')						10/03/18
0008.00		A		XWB3CD	11A	TEXT('Related Account')						01/05/07
0008.01		A				COLHDG('Related' 'Account')						10/03/18
0009.00		A		XWHITX	15A	TEXT('Tax Reg')						01/05/07
0009.01		A				COLHDG('Tax' 'Registration')						10/03/18
0010.00		A		XWE0NB	9P 0	TEXT('Bank')						01/05/07
0010.01		A				COLHDG('Bank' 'Transit #')						10/03/18
0011.00		A				EDTCDE(4)						00/00/00
0012.00		A		XWJUN0	15P 0	TEXT('Bank A/c')						01/05/07
0012.01		A				COLHDG('Bank' 'Account #')						10/03/18
0013.00		A				EDTCDE(3)						00/00/00
0014.00		A		XWDVCD	3A	TEXT('Forex')						01/05/07
0014.01		A				COLHDG('Forex')						10/03/18
0015.00		A		XWBNCD	2A	TEXT('CusGrp')						01/05/07
0015.01		A				COLHDG('Customer' 'Group')						10/03/18
0016.00		A		PERSON	3A	TEXT('Rep')						01/05/07
0016.01		A				COLHDG('Rep')						10/03/18
0017.00		A		DSDCDE	2A	TEXT('Distributor')						05/08/01
0017.01		A				COLHDG('Dist')						10/03/18
0018.00		A		XWBTCDE	3A	TEXT('Terms')						01/05/07
0018.01		A				COLHDG('Terms')						10/03/18
0019.00		A		XWGIVA	15P 2	TEXT('Credit Limit')						01/05/07

0019.01	A			COLHDG('Credit' 'Limit')	10/03/18
0020.00	A			EDTCDE(M)	00/00/00
0021.00	A	XWA OCD	3A	TEXT('Stl Dsc')	01/05/07
0021.01	A			COLHDG('Stl' 'Dsc')	10/03/18
0022.00	A	XWBBCD	3A	TEXT('Int')	01/05/07
0022.01	A			COLHDG('Int')	10/03/18
0023.00	A	XWG4T0	10A	TEXT('Cr Guarantee')	01/05/07
0023.01	A			COLHDG('Cr' 'Guarantee')	10/03/18
0024.00	A	XWC7ST	1A	TEXT('B/O')	01/05/07
0024.01	A			COLHDG('B/O')	10/03/18
0025.00	A	XWDAST	1A	TEXT('Lang')	01/05/07
0025.01	A			COLHDG('Lang')	10/03/18
0026.00	A	XWBPD0	L	TEXT('Date Loaded')	01/05/07
0026.01	A			COLHDG('Date' 'Loaded')	10/03/18
0027.00	A	XWBAD0	L	TEXT('Chg-Date')	01/05/07
0027.01	A			COLHDG('Change' 'Date')	10/03/18
0028.00	A	XWARDT	L	TEXT('Last Sale')	01/05/07
0028.01	A			COLHDG('Last' 'Sales' 'Date')	10/03/18
0029.00	A	XWF0VA	15P 2	TEXT('Amt Last Sale')	01/05/07
0029.01	A			COLHDG('Amount' 'Last' 'Sale')	10/03/18
0030.00	A			EDTCDE(M)	00/00/00
0031.00	A	XWASDT	L	TEXT('Date Last Pay')	01/05/07
0031.01	A			COLHDG('Date' 'Last' 'Payed')	10/03/18
0032.00	A	XWF0V0	15P 2	TEXT('Last Pay')	01/05/07
0032.01	A			COLHDG('Last' 'Pay' 'Amount')	10/03/18
0033.00	A			EDTCDE(M)	00/00/00
0034.00	A	XWBQDT	L	TEXT('Date Last Stmt')	01/05/07
0034.01	A			COLHDG('Date' 'Last' 'Statement')	10/03/18
0035.00	A	XWF1VA	15P 2	TEXT('Curr Pay')	01/05/07
0035.01	A			COLHDG('Curr' 'Pay')	10/03/18
0036.00	A			EDTCDE(M)	00/00/00
0037.00	A	XWF1V0	15P 2	TEXT('Curr Claim')	01/05/07
0037.01	A			COLHDG('Curr' 'Claim')	10/03/18
0038.00	A			EDTCDE(M)	00/00/00

---

0039.00	A	XWF2VA	15P 2	TEXT('Curr Sls')	01/05/07
0039.01	A			COLHDG('Curr' 'Sls')	10/03/18
0040.00	A			EDTCDE(M)	00/00/00
0041.00	A	XWF3VA	15P 2	TEXT('Curr Cost')	01/05/07
0041.01	A			COLHDG('Curr' 'Cost')	10/03/18
0042.00	A			EDTCDE(M)	00/00/00
0043.00	A	XWF4VA	15P 2	TEXT('Ytd Sales')	01/05/07
0043.01	A			COLHDG('Ytd' 'Cost')	10/03/18
0044.00	A			EDTCDE(M)	00/00/00
0045.00	A	XWF6VA	15P 2	TEXT('Last Year Sls')	01/05/07
0045.01	A			COLHDG('Last' 'Year' 'Sls')	10/03/18
0046.00	A			EDTCDE(M)	00/00/00
0047.00	A	XWIDV0	15P 2	TEXT('Balance')	01/05/07
0047.01	A			COLHDG('Balance')	10/03/18
0048.00	A			EDTCDE(M)	01/05/07
0049.00	A	XWGAVA	15P 2	TEXT('Current Amt')	01/05/07
0049.01	A			COLHDG('Current' 'Amount')	10/03/18
0050.00	A			EDTCDE(M)	01/05/07
0051.00	A	XWGBVA	15P 2	TEXT('030 Days')	01/05/07
0051.01	A			COLHDG('30' 'Days' 'Amount')	10/03/18
0052.00	A			EDTCDE(M)	01/05/07
0053.00	A	XWGCVA	15P 2	TEXT('060 Days')	01/05/07
0053.01	A			COLHDG('60' 'Days' 'Amount')	10/03/18
0054.00	A			EDTCDE(M)	01/05/07
0055.00	A	XWGDVA	15P 2	TEXT('090 Days')	01/05/07
0055.01	A			COLHDG('90' 'Days' 'Amount')	10/03/18
0056.00	A			EDTCDE(M)	01/05/07
0057.00	A	XWGEVA	15P 2	TEXT('120 Days')	01/05/07
0057.01	A			COLHDG('120' 'Days' 'Amount')	10/03/18
0058.00	A			EDTCDE(M)	01/05/07
0059.00	A	XWGFVA	15P 2	TEXT('150 Days')	01/05/07
0059.01	A			COLHDG('150' 'Days' 'Amount')	10/03/18
0060.00	A			EDTCDE(M)	01/05/07
0061.00	A	XWGGVA	15P 2	TEXT('180 Days')	01/05/07

0061.01	A			COLHDG('180' 'Days' 'Amount')	10/03/18
0062.00	A			EDTCDE(M)	01/05/07
0063.00	A	CUSNO	5P 0	TEXT('Prospect No')	01/05/07
0063.01	A			COLHDG('Prodect' 'Number')	10/03/18
0064.00	A				01/05/07
0065.00	A	K XWBCCD			00/00/00



**Source for CUSTSL3**

<i>Seq No</i>	<i>*</i>	<i>1</i>	<i>2</i>	<i>3</i>	<i>4</i>	<i>5</i>	<i>6</i>	<i>7</i>	<i>8</i>	<i>9</i>	<i>*</i>	<i>Date Changed</i>
0001.00	A		R	CUSTSR		PFILE(CUSTS)						01/05/07
0002.00	A											00/00/00
0003.00	A		K	CUSNO								01/05/07
0004.00	A		K	PERSON								01/05/07

## Source for OE001DF

Seq No	*	1	2	3	4	5	6	7	8	9	*	Date Changed
0001.00	A					CA03(03 'Exit')						00/00/00
0002.00	A					PRINT						00/00/00
0003.00	A*	Subfile Record										00/00/00
0004.00	A*											99/09/07
0005.00	A		R OESFL			SFL						00/00/00
0006.00	A		OLLNNO		5S 00 12 2							00/00/00
0007.00	A					DSPATR(HI)						00/00/00
0008.00	A		OLPROD		5S 0B 12 9							00/00/00
0009.00	A					DSPATR(HI)						00/00/00
0010.00	A	35				DSPATR(PR)						00/00/00
0011.00	A		PRDESC		30A O 12 20							00/00/00
0012.00	A					DSPATR(HI)						00/00/00
0013.00	A		OLQTY		5S 0B 12 61							00/00/00
0014.00	A					DSPATR(HI)						00/00/00
0015.00	A	35				DSPATR(PR)						00/00/00
0016.00	A*											00/00/00
0017.00	A*	Subfile Control Record										00/00/00
0018.00	A		R OESFLC			SFLCTL(OESFL)						00/00/00
0019.00	A					SFLSIZ(10)						00/00/00
0020.00	A					SFLPAG(10)						00/00/00
0021.00	A	N33				SFLDSP						00/00/00
0022.00	A	N30				SFLDSPCTL						00/00/00
0023.00	A	30				SFLDLT						00/00/00
0024.00	A					BLINK						00/00/00
0025.00	A					KEEP						00/00/00
0026.00	A					OVERLAY						00/00/00
0027.00	A					PUTOVR						00/00/00
0028.00	A		@@PGM		10A O 1	2TEXT('Program Name')						00/00/00
0029.00	A					OVRDTA						00/00/00
0030.00	A				1 27	O R D E R E N T R Y'						00/00/00

0031.00	A				DSPATR(HI)	00/00/00
0032.00	A				DSPATR(UL)	00/00/00
0033.00	A			1	62TIME	00/00/00
0034.00	A				OVRATR	00/00/00
0035.00	A			1	72DATE	00/00/00
0036.00	A				OVRATR	00/00/00
0037.00	A				EDTCDE(Y)	00/00/00
0038.00	A			3	2'Order No: '	00/00/00
0039.00	A	DSORDN	5S	0B	3 13	00/00/00
0040.00	A				OVRDTA OVRATR	00/00/00
0041.00	A	34			DSPATR(PR)	00/00/00
0042.00	A			3	25'Customer'	00/00/00
0043.00	A	CSNAME	34A	O	3 35	00/00/00
0044.00	A				OVRDTA	00/00/00
0045.00	A				DSPATR(HI)	00/00/00
0046.00	A			4	2'Customer No: '	00/00/00
0047.00	A	DSCSNO	5S	0B	4 16	00/00/00
0048.00	A				OVRDTA OVRATR	00/00/00
0049.00	A	N34			DSPATR(PC)	95/09/20
0050.00	A	34			DSPATR(PR)	00/00/00
0051.00	A			4	25'Address'	00/00/00
0052.00	A	CSADD1	34A	O	4 35	00/00/00
0053.00	A				OVRDTA	00/00/00
0054.00	A				DSPATR(HI)	00/00/00
0055.00	A	CSADD2	34A	O	5 35	00/00/00
0056.00	A				OVRDTA	00/00/00
0057.00	A				DSPATR(HI)	00/00/00
0058.00	A	CSADD3	34A	O	6 35	00/00/00
0059.00	A				OVRDTA	00/00/00
0060.00	A				DSPATR(HI)	00/00/00
0061.00	A	CSPSCD	8A	O	7 35	00/00/00
0062.00	A				OVRDTA	00/00/00
0063.00	A				DSPATR(HI)	00/00/00
0064.00	A*					00/00/00

0065.00	A		8	2	'Order Lines:'		00/00/00
0066.00	A		10	2	'Line'		00/00/00
0067.00	A		10	9	'Product'		00/00/00
0068.00	A		10	20	'Description'		00/00/00
0069.00	A		10	55	'Quantity'		00/00/00
0070.00	A*						00/00/00
0071.00	A*	Trailer Record					00/00/00
0072.00	A	R OETRL					00/00/00
0073.00	A				KEEP		00/00/00
0074.00	A				OVERLAY		00/00/00
0075.00	A				PUTOVR		00/00/00
0076.00	A	CMDDTA	78A	0	24	2	00/00/00
0077.00	A				OVRDTA		00/00/00
0078.00	A*						00/00/00
0079.00	A*	Clear Screen Record					00/00/00
0080.00	A	R OECLR					00/00/00
0081.00	A		12	9	' '		00/00/00

**Source for PTYPES**

<i>Seq No</i>	<i>*</i>	<i>1</i>	<i>2</i>	<i>3</i>	<i>4</i>	<i>5</i>	<i>6</i>	<i>7</i>	<i>8</i>	<i>9</i>	<i>*</i>	<i>Date Changed</i>
0001.00	A		R	RPRODS								95/12/12
0002.00	A			PRPCDE	2A	TEXT('Code')						05/08/01
0003.00	A			PDESF	34A	TEXT('Description')						01/03/24
0004.00	A			PQTY	7P 2	TEXT('Quantity')						01/03/24
0005.00	A			PUNT	20A	TEXT('Unit')						01/03/24
0006.00	A			PPRC	7P 2	TEXT('Price')						01/03/24
0007.00	A		K	PRPCDE								05/08/01
0007.01	A		K	PDESF								08/11/18
0007.02	A		K	PQTY								08/11/18
0007.03	A		K	PUNT								08/11/18
0007.04	A		K	PPRC								08/11/18

## Source for QLETSRC

*Seq No \*...+... 1 ...+... 2 ...+... 3 ...+... 4 ...+... 5 ...+... 6 ...+... 7 ...+... 8 ...+... 9 ...+... \* Date Changed*

FORMAT: QLETSRC

FIELDS: SRCSEQ 6S 2

SRCDAT 6S 0

SRCDTA 80A

## Source for OE001

Seq No	1	2	3	4	5	6	7	8	9	* Date Changed
0001.00	FOE001DF	CF	E		WORKSTN					08/06/11
0002.00	F				@RRN1	KSF	FILE	OESFL		92/08/07
0003.00	FCUSTSL3	UF	E	K	DISK			A		01/06/08
0004.00	FPTYPES	IF	E	K	DISK					01/02/08
0005.00	F*									92/09/30
0006.00	E		CMD	1	3	78		CMD Key Data		92/09/30
0007.00	E*									92/09/30
0014.00	I*									92/09/30
0015.00	C*****									92/08/07
0016.00	C* Receive Parameters									92/08/07
0021.00	C* Until F3									92/08/07
0024.00	C* Initialise screen									01/02/20
0032.00	* Retrieve last order number									95/09/20
0033.00	C		*HIVAL	SETGTCUSTSL3						01/06/08
0034.00	C		READPCUSTSR			4040				01/06/08
0040.00	*									95/09/20
0043.00	C		CALL	'CUSLET'						05/01/13
0046.00	C* Get Order No. & Customer No.									92/09/30
0047.00	C		WRITEOECLR			99				92/09/30
0048.00	C		WRITEOETRL			99				92/08/07
0049.00	C		EXFMTOESFLC			99				92/08/07
0051.00	C* So long as Exit not requested #1									92/09/30
0054.00	C* Retrieve Customer Details									01/02/20
0055.00	C		EXSR	\$RVCUS						92/09/30
0057.00	C* Set up blank subfile for Order lines									92/09/30
0058.00	C		EXSR	\$ORLNS						92/09/30
0060.00	C* Display Order Entry screen									92/09/30
0064.00	C		WRITEOETRL			99				92/08/07
0065.00	C		EXFMTOESFLC			99				92/08/07
0067.00	C* So long as Exit not requested #2									92/09/30

0070.00	C*	Validate Order Data				92/09/30
0071.00	C	EXSR \$VALID				92/09/30
0073.00	C*	Redisplay Order Entry screen				92/09/30
0075.00	C	WRITEOETRL	99			92/09/30
0076.00	C	EXFMTOESFLC	99			92/09/30
0078.00	C*	So long as Exit not requested #3				92/09/30
0081.00	C*	Create Order				92/09/30
0082.00	C	EXSR \$CRORD				92/09/30
0083.00	C*	Delete SFL				92/08/07
0085.00	C	WRITEOESFLC	99			92/08/07
0088.00	C*	End: So long as Exit not requested #3				92/09/30
0091.00	C*	End: So long as Exit not requested #2				92/09/30
0094.00	C*	End: So long as Exit not requested #1				92/09/30
0097.00	C*	End: Until F3				92/08/07
0100.00	C*	Terminate Program				92/08/07
0103.00	C	RETRN				92/08/07
0104.00	C	*****				92/08/07
0106.00	C	*****				00/00/00
0107.00	C	\$RVCUS BEGSR				92/09/30
0109.00	C*	Get Customer Record				92/08/07
0110.00	C	CUSNO CHAINCUSTSR	4040		@@REDR	01/06/08
0119.00	C	ENDSR				92/09/30
0120.00	C	*****				92/09/30
0122.00	C	*****				92/09/30
0123.00	C	\$ORLNS BEGSR				92/09/30
0125.00	C*	Set up blank order lines ****				01/02/22
0134.00	C	WRITEOESFL	31		@@SF01	92/09/30
0137.00	C	ENDSR				92/09/30
0138.00	C	*****				92/09/30
0140.00	C	*****				92/09/30
0141.00	C	\$CRORD BEGSR				92/09/30
0143.00	C*	Create Order				92/09/30
0145.00	C*	1. Order Header				92/09/30
0146.00	C	CUSNO CHAINCUSTSR	4040		@@REDR	01/06/08



0149.00	C		UPDATCUSTSR	55		01/06/08
0152.00	C		WRITECUSTSR	55		01/06/08
0155.00	C*	2. Order Details				92/09/30
0162.00	C	@RRN1	CHAINOESFL	4242	@@REDR	92/09/30
0164.00	C*	If successfully retrieved				92/09/30
0168.00	C*	If data entered				92/09/30
0171.00	C	CUSNO	CHAINCUSTSR	4141	@@REDR	01/06/08
0173.00	C		UPDATCUSTSR	55		01/06/08
0175.00	C		WRITECUSTSR	55		01/06/08
0178.00	C*	End: If data entered				92/09/30
0181.00	C*	End: If successfully retrieved				92/09/30
0185.00	C*	End: For each record in subfile				92/09/30
0188.00	C		ENDSR			00/00/00
0189.00	C	*****				00/00/00
0191.00	C	*****				92/09/30
0192.00	C	\$VALID	BEGSR			92/09/30
0194.00	C*	Validate Order				92/09/30
0202.00	C	@RRN1	CHAINOESFL	4141	@@REDR	92/09/30
0204.00	C*	If successfully retrieved				92/09/30
0207.00	C*	If data entered				92/09/30
0210.00	C*	Validate Product & Get Product Description				92/09/30
0211.00	C	PRPCDE	CHAINRPRODS	4242	@@REDR	05/08/26
0213.00	C		UPDATOESFL	31	@@SF01	92/09/30
0215.00	C*	End: If data entered				92/09/30
0218.00	C*	End: If successfully retrieved				92/09/30
0222.00	C*	End: For each record in subfile				92/09/30
0227.00	C		ENDSR			92/09/30
0228.00	C	*****				92/09/30
0229.00	C*	Definitions				92/09/30
0235.00	C	*****				92/09/30
0236.00**						92/09/30
0237.00F3=Exit						92/09/30
0238.00F3=Exit	ENTER=continue					92/09/30
0239.00F3=Exit	Enter Order Lines, then ENTER to continue					92/09/30

**Source for OE001DF**

Previously documnted

**Source for CUSTSL3**

<i>Seq No</i>	<i>*</i>	<i>1</i>	<i>2</i>	<i>3</i>	<i>4</i>	<i>5</i>	<i>6</i>	<i>7</i>	<i>8</i>	<i>9</i>	<i>*</i>	<i>Date Changed</i>
0001.00	A		R	CUSTSR		PFILE(CUSTS)						01/05/07
0002.00	A											00/00/00
0003.00	A		K	CUSNO								01/05/07
0004.00	A		K	PERSON								01/05/07

## **Source for PTYPES**

[Previously documnted](#)

## Source for CUSLET

Seq No	*	1	2	3	4	5	6	7	8	9	*	Date Changed
0008.00		CALL	CUSLET1	(&CUSNC)								05/01/13
0008.01		/*	MONMSG	CPF0000	*/							11/09/22

**Source for CUSLET1**

<i>Seq No</i>	<i>*..... 1</i>	<i>..... 2</i>	<i>..... 3</i>	<i>..... 4</i>	<i>..... 5</i>	<i>..... 6</i>	<i>..... 7</i>	<i>..... 8</i>	<i>..... 9</i>	<i>*.....</i>	<i>Date Changed</i>
0004.01/*		DCL	VAR(&TRNNO)	TYPE(*DEC)	LEN(5 0)	*/					11/09/22
0010.00		CALL	LETN1	(&CUSNO	&PREFIX	&LETSQ)					96/01/08
0010.01		/*	MONMSG	MSGID(CPF0000)	*/						11/09/06
0014.00		CALL	WKCUSL	(&CUSNC	PREFIX	&LETNR)					01/02/01

**Source for LETN1**

<i>Seq No</i>	<i>*</i>	<i>1</i>	<i>2</i>	<i>3</i>	<i>4</i>	<i>5</i>	<i>6</i>	<i>7</i>	<i>8</i>	<i>9</i>	<i>*</i>	<i>Date Changed</i>
0001.00		FCUSFL3	IF E	K	DISK							07/03/17
0006.00		C	CUSNO	CHAINCUSFL3		81						95/12/14
0010.00		C		RETRN								95/12/14

**Source for CUSFL3**

<i>Seq No</i>	<i>*</i>	<i>1</i>	<i>2</i>	<i>3</i>	<i>4</i>	<i>5</i>	<i>6</i>	<i>7</i>	<i>8</i>	<i>9</i>	<i>*</i>	<i>Date Changed</i>
0001.00	A					UNIQUE						90/07/27
0002.00	A		R	RCUSF		PFILE(CUSF)						90/07/27
0003.00	A		K	CUSNO								00/00/00
0003.01												16/11/21



**Source for WKCUSL**

Seq No	*	1	2	3	4	5	6	7	8	9	*	Date Changed	
0012.01	*		DCL	VAR(&SWITC1)	TYPE(*LGL)	LEN(1)		*/				11/09/22	
0031.01	*		MONMSG	MSGID(CPF0000)						*/		11/09/22	
0051.00			CALL	CUSLETSQ	(&cusnc	&LETNR)						94/07/20	
0051.01	*		CALL	CUSLETSR	(&cusnc	&LETNR)		*/				11/09/13	
0077.00	*		Generate	Customer	Letter					*/		90/12/21	
0083.00			IF	&FAX	CALL	WKCUS8EF	(&CUSNC	&FAXNO)				94/08/19	
0086.00			CALL	WKCUS8E	(&CUSNC	&TYPE	&VER	&USRTXT	&FAXNO	&SKL	' '	+	95/04/05
0087.00				' '	)							95/04/05	
0089.00	*		Display	the	Customer	Letter				*/		90/12/21	
0124.00	*		Print	the	Customer	Letter				*/		90/12/21	
0138.00			CALL	PGM	(WKCUS8P)							90/12/21	

**Source for QLETSRC**

Previously documnted

**Source for CUSLETSQ**

<i>Seq No</i>	<i>*</i>	<i>1</i>	<i>2</i>	<i>3</i>	<i>4</i>	<i>5</i>	<i>6</i>	<i>7</i>	<i>8</i>	<i>9</i>	<i>*</i>	<i>Date Changed</i>
0001.00		FCUSFL3	UF	E	K	DISK						07/03/17
0006.00		C		CUSNO	CHAINCUSFL3			81				94/05/19
0008.00		C	N81		UPDATRCUSF							94/05/19

**Source for WKCUS8EF**

Seq No	*	1	2	3	4	5	6	7	8	9	*	Date Changed
0001.00		FCUSFL3	IF E	K	DISK							07/03/17
0002.00		E		@TEL	17	1						93/11/25
0003.00		E		FAX	12	1						93/11/26
0004.00		E		@FAX	17	1						93/11/26
0005.00		E		@WA	17	1						93/11/25
0016.01		C****										11/09/14
0018.00		C	CUSNO	CHAINCUSFL3			LR					93/11/25
0019.00		C*	If record found.									93/11/25
0022.00		C*	Terminate if there is no fax number on the database.									93/11/26
0024.00		C*	Extract fax number digits. Store its length in @F.									93/11/26
0033.00		C*	If there is no telephone number on the database then terminate									93/11/26
0034.00		C*	with the current fax number on the database.									93/11/26
0038.00		C*	Extract telephone number digits (minus any extension number)									93/11/25
0039.00		C*	Store its length in @T.									93/11/26
0052.00		C*	If the fax number is longer than the telephone number then									93/11/26
0053.00		C*	terminate with the current fax number on the database.									93/11/26
0057.00		C*	If the fax number is shorter than the telephone number then									93/11/25
0058.00		C*	prefix the beginning digits of the telephone number to the fax									93/11/25
0059.00		C*	number to make up the length.									93/11/25
0060.00		C*	Eg.									93/11/25
0061.00		C*	Tel No. 0932 829222 x14 ; Fax No. 854468									93/11/26
0062.00		C*	Fax Number would become 0932854468									93/11/26
0067.00		C*	Punctuate the fax number with '-'. Use the telephone number to									93/11/26
0068.00		C*	decide where to punctuate.									93/11/26
0069.00		C*	Eg.									93/11/26
0070.00		C*	Tel No. (0932) 829222 x14 ; Fax No. 854468									93/11/26
0071.00		C*	Fax Number would become 0932-854468									93/11/26
0077.00		C		EXSR \$NEXT								93/11/26
0090.00		C		EXSR \$NEXT								93/11/26
0094.00		C	FINISH	TAG								93/11/26

0096.00	C* End: record found.	93/11/25
0098.00	C RETRN	93/11/25
0100.00	C \$NEXT BEGSR	93/11/26
0101.00	C* Read upto next character in telephone number string to process.	93/11/26
0114.00	C ENDSR	93/11/26

**Source for WKCUS8E**

Seq No	1	2	3	4	5	6	7	8	9	* Date Changed
0001.00	*****									07/03/17
0002.00	*									94/01/14
0003.00	*	WKCUS8E								94/01/14
0004.00	*	LETTER GENERATING PROGRAM.								94/01/14
0005.00	*									94/01/14
0006.00	*****									94/07/05
0007.00	FCUSFL3	IF	E	K	DISK				90/12/17	
0008.00	FQLETSRC	IF	E	DISK	KINFDS	FINDS	A			93/11/26
0009.00	F	QLETSRC			KRENAME@LETSRC				90/12/18	
0010.00	FQSKLSRC	IF	E	DISK	KINFDS	FINDS2	UC			94/01/25
0011.00	F	QSKLSRC			KRENAME@SKLSRC				93/12/09	
0012.00	FQSIGSRC	IF	E	DISK			UC			94/07/15
0013.00	F	QSIGSRC			KRENAME@SIGSRC				94/07/15	
0014.00	E	TXT	80	1						90/12/13
0015.00	E	LOG	1	8	80	Logo				95/02/01
0016.00	E	DAY	1	31	4					90/12/13
0017.00	E	MTH	1	12	9					90/12/13
0018.00	E	RLS	1	3	60					90/12/21
0019.00	E	BCH	1	3	60					90/12/21
0020.00	E	SEC	1	3	65					92/02/03
0021.00	E	PRF	1	35	80					91/05/29
0022.00	E	FSR	1	6	80					96/01/30
0086.00	C	CUSNO	CHAINCUSFL3	99						90/12/13
0088.00	*****									94/01/14
0089.00	*									94/01/14
0090.00	*	TYPE PARAMETER DETERMINES THE TYPE OF LETTER								94/02/17
0091.00	*	PROCESSED:								94/01/14
0092.00	*	P: PROFORMA LETTER								94/01/14
0093.00	*	S: SECURITY LETTER								94/01/14
0094.00	*	BLANK: ALL THE OTHER LETTER TYPES.								94/02/17

0095.00	*				94/01/14
0096.00	*****				94/01/14
0097.00	*				94/02/17
0098.00	C	TYPE	CASEQ 'P'	PROFOR	91/05/29
0099.00	C	TYPE	CASEQ 'S'	SECURT	92/02/03
0100.00	C	TYPE	CASEQ 'M'	MEMO	94/07/05
0101.00	C		CAS	LETTER	91/05/29
0102.00	C		END		91/05/29
0104.00	*				93/11/25
0107.00AC	C		EXSR FAXSTR		94/02/16
0109.00	*				93/11/25
0111.00	CLRNL		READ QLETSRC	LR	91/05/29
0112.00	*****				94/01/14
0113.00	*				94/01/14
0114.00	*		PROCESS PROFORMA LETTER	(Type P)	94/02/17
0115.00	*				94/01/14
0116.00	*****				94/01/14
0117.00	C	PROFOR	BEGSR		91/05/29
0120.00AC	C		EXSR FAXSTR		95/04/06
0123.00AC	C		WRITE@LETSRC		95/04/06
0127.00	C		WRITE@LETSRC		91/05/29
0132.00	*				91/05/29
0174.00	*				91/05/29
0175.00	C		WRITE@LETSRC		91/05/29
0177.00	C		ENDSR		91/05/29
0178.00	*****				94/01/14
0179.00	*		PROCESS SECURITY LETTER	(Type S)	94/02/17
0180.00	*****				94/01/14
0181.00	C	SECURT	BEGSR		92/02/03
0184.00AC	C		EXSR FAXSTR		95/04/06
0186.00AC	C		EXSR FAXSTR		96/01/30
0189.00AC	C		WRITE@LETSRC		95/04/06
0191.00	*	Blank lines at top of letter (originally 17):			94/07/05
0194.00	C		WRITE@LETSRC		92/02/03

0211.00	*			92/02/03
0215.00	C		WRITE@LETSRC	92/02/03
0218.00	*			92/02/03
0222.00	C		WRITE@LETSRC	92/02/03
0225.00	*			92/11/05
0228.00	C		WRITE@LETSRC	94/07/28
0230.00	*			92/02/03
0235.00	C		WRITE@LETSRC	92/02/03
0238.00	*			92/02/07
0241.00	C		WRITE@LETSRC	92/02/07
0243.00	*			92/02/03
0246.00	C		WRITE@LETSRC	92/02/03
0248.00	*			92/02/03
0249.00	C		ENDSR	92/02/03
0250.00			*****	94/07/05
0251.00	*		MEMO	94/07/05
0252.00			*****	94/07/05
0253.00	C	MEMO	BEGSR	94/07/05
0256.00AC	C		EXSR FAXSTR	95/04/06
0258.00AC	C		EXSR FAXSTR	96/01/30
0263.00	C		WRITE@LETSRC	95/02/02
0267.00	C		WRITE@LETSRC	95/02/01
0268.00	*			95/02/01
0283.00	C		WRITE@LETSRC	94/07/05
0288.00	C		WRITE@LETSRC	94/07/05
0293.00	C		WRITE@LETSRC	94/07/05
0298.00	C		WRITE@LETSRC	94/07/05
0300.00	*			94/07/05
0303.00	C		WRITE@LETSRC	94/07/05
0305.00	*			94/07/05
0309.00	C		WRITE@LETSRC	94/07/05
0311.00	*			94/07/05
0314.00	C		WRITE@LETSRC	94/07/05
0316.00	*			94/07/05



0319.00	C	WRITE@LETSRC	94/07/05
0320.00	*		94/07/05
0322.00	C	ENDSR	94/07/05
0323.00		*****	94/01/14
0324.00	*	PROCESS ALL OTHER LETTER TYPES	94/02/17
0325.00	*	(Type: SKLnnn,B,C,E,F,I,O,R)	94/02/17
0326.00		*****	94/01/14
0327.00	C	LETTER BEGSR	91/05/29
0330.00AC	C	EXSR FAXSTR	95/04/06
0332.00	C	WRITE@LETSRC	95/04/06
0338.00	C	EXSR FAXSTR	95/04/06
0342.00AC	C	WRITE@LETSRC	95/04/06
0347.00	C	WRITE@LETSRC	91/05/29
0363.00	C	WRITE@LETSRC	90/12/18
0365.00	*		90/12/13
0369.00	C	WRITE@LETSRC	90/12/18
0372.00	*		90/12/13
0376.00	C	WRITE@LETSRC	90/12/18
0379.00	*		90/12/13
0383.00	C	WRITE@LETSRC	90/12/18
0386.00	*		90/12/13
0390.00	C	WRITE@LETSRC	90/12/18
0393.00	*		90/12/13
0397.00	C	WRITE@LETSRC	90/12/18
0400.00	*		90/12/13
0404.00	C	WRITE@LETSRC	90/12/18
0407.00	*		90/12/13
0411.00	C	WRITE@LETSRC	90/12/18
0414.00	*		90/12/13
0417.00	C	WRITE@LETSRC	90/12/18
0419.00	*		90/12/13
0421.00	C	*LOCK IN ORDNO	91/06/04
0423.00	C	OUT ORDNO	91/06/04
0427.00	C	WRITE@LETSRC	91/06/04

0432.00	C	WRITE@LETSRC		91/06/04
0435.00	C	WRITE@LETSRC		91/06/04
0442.00	C	WRITE@LETSRC		91/06/04
0448.00	C	WRITE@LETSRC		90/12/18
0451.00	*			90/12/13
0453.00	C	OPEN QSKLSRC		93/12/09
0454.00	C	READ QSKLSRC	99	93/12/09
0457.00	C	WRITE@LETSRC		93/12/09
0458.00	C	READ QSKLSRC	99	93/12/09
0460.00	C	CLOSEQSKLSRC		93/12/09
0463.00	*			93/12/09
0466.00	C	WRITE@LETSRC		90/12/18
0468.00	*			90/12/13
0479.00	C	WRITE@LETSRC		90/12/18
0482.00	*			90/12/13
0485.00	C	WRITE@LETSRC		90/12/18
0487.00	*			91/06/04
0494.00	C	WRITE@LETSRC		91/06/04
0496.00	*			91/06/04
0502.00	C	WRITE@LETSRC		91/06/04
0504.00	*			91/06/04
0510.00	C	WRITE@LETSRC		91/06/04
0512.00	*			91/06/04
0517.00	C	WRITE@LETSRC		91/06/04
0519.00	*			91/06/04
0522.00	C	WRITE@LETSRC		91/06/04
0526.00	*			90/12/13
0533.00	C	WRITE@LETSRC		90/12/18
0534.00	*			94/07/15
0536.00	C	OPEN QSIGSRC	99	94/07/15
0540.00	C	READ QSIGSRC	99	94/07/15
0543.00	C	WRITE@LETSRC		94/07/15
0544.00	C	READ QSIGSRC	99	94/07/15
0546.00	C	CLOSEQSIGSRC		94/07/15

0548.00	*			94/07/15
0550.00	*			90/12/13
0553.00	C	WRITE@LETSRC		90/12/18
0555.00	*			90/12/13
0558.00	C	WRITE@LETSRC		94/07/15
0559.00	*			94/01/14
0561.00	*			94/07/15
0563.00	*			94/01/14
0565.00	C	ENDSR		91/05/29
0566.00	*			94/01/14
0567.00	*	*****		94/01/14
0568.00	*			94/01/14
0569.00	*	OUTPUT FAX*STAR DIRECTIVES		95/04/05
0570.00	*			94/01/14
0571.00	*	*****		94/01/14
0572.00	C	FAXSTR BEGSR		93/11/25
0576.00	*	LX =2		96/01/05
0599.00	*	LX=5		96/01/05
0606.00	*			96/01/05
0607.00	*	LX=6		96/01/30
0609.00	*			96/01/30
0614.00	*			96/01/05
0616.00	C	WRITE@LETSRC		93/11/25
0618.00	C	ENDSR		93/11/26
0619.00	*			90/12/13
0620.00**				90/12/13
0621.00		=====	D A T A B O R O U G H L T D .	95/02/01
0622.00		=====	BEACON HOUSE	95/02/01
0623.00		=====	SOUTH ROAD	95/02/01
0624.00		==	WEYBRIDGE	95/02/01
0625.00		==	SURREY	95/02/01
0626.00		=====	KT13 9DZ	95/02/01
0627.00		=====	TEL: +44 1932 848564	95/02/01
0628.00		=====	FACSIMILE MESSAGE FAX: +44 1932 854468	95/02/01

0629.00**	95/02/01
0630.001st	90/12/13
0631.002nd	90/12/13
0632.003rd	90/12/13
0633.004th	90/12/13
0634.005th	90/12/13
0635.006th	90/12/13
0636.007th	90/12/13
0637.008th	90/12/13
0638.009th	90/12/13
0639.0010th	90/12/13
0640.0011th	90/12/13
0641.0012th	90/12/13
0642.0013th	90/12/13
0643.0014th	90/12/13
0644.0015th	90/12/13
0645.0016th	90/12/13
0646.0017th	90/12/13
0647.0018th	90/12/13
0648.0019th	90/12/13
0649.0020th	90/12/13
0650.0021st	90/12/13
0651.0022nd	90/12/13
0652.0023rd	90/12/13
0653.0024th	90/12/13
0654.0025th	90/12/13
0655.0026th	90/12/13
0656.0027th	90/12/13
0657.0028th	90/12/13
0658.0029th	90/12/13
0659.0030th	90/12/13
0660.0031st	90/12/13
0661.00**	90/12/13
0662.00January	90/12/13

0663.00	February	90/12/13
0664.00	March	90/12/13
0665.00	April	90/12/13
0666.00	May	90/12/13
0667.00	June	90/12/13
0668.00	July	90/12/13
0669.00	August	90/12/13
0670.00	September	90/12/13
0671.00	October	90/12/13
0672.00	November	90/12/13
0673.00	December	90/12/13
0674.00	**	90/12/13
0675.00	Please find enclosed a cartridge containing version nn.nn of	90/12/20
0676.00	X-Analysis and a 3.5" diskette containing the User Guide in	90/12/17
0677.00	Wordperfect format.	90/12/13
0678.00	**	90/12/21
0679.00	Please find enclosed the current X-Analysis brochure and	90/12/21
0680.00	price list. If we can be of further assistance or you would	90/12/21
0681.00	like a demonstration , please do not hesitate to call.	90/12/21
0682.00	**	91/07/30
0683.00	Code for serial no.: xxxxxxxx is XXXXXXXXXXXXXXXXXXXXXXXX	92/01/31
0684.00	Use CHGDTAARA to enter code in data area X@SEC in library X@OBJ.	94/07/28
0685.00		92/01/31
0686.00	**	91/05/29
0687.00	PRO-FORMA DECLARATION	91/05/29
0688.00		91/05/29
0689.00		91/05/29
0690.00	CONSIGNEE NAME : XXX XXXXXXXXX	91/05/29
0691.00		91/05/29
0692.00		91/05/29
0693.00		91/05/29
0694.00		91/05/29
0695.00		91/05/29
0696.00		91/05/29

0697.00		91/05/29
0698.00		91/05/29
0699.00	DESCRIPTION OF GOODS : 1 Computer Data Cartridge	91/05/29
0700.00		91/05/29
0701.00	VALUE AND CURRENCY : #20.00 (Pounds Sterling)	91/05/29
0702.00		91/05/29
0703.00	WEIGHT : 0.3 Kg	91/05/29
0704.00		91/05/29
0705.00	DIMENSIONS : 16 x 10.5 x 2 cm	91/05/29
0706.00		91/05/29
0707.00	REASON FOR EXPORT : Business Purposes	91/05/29
0708.00		91/05/29
0709.00	COUNTRY OF ORIGIN : United Kingdom	91/05/29
0710.00		91/05/29
0711.00	NAME OF SENDER :	91/05/29
0712.00		91/05/29
0713.00		91/05/29
0714.00		91/05/29
0715.00	I Hereby declare the above information is true and correct to	91/05/29
0716.00	the best of my knowledge.	91/05/29
0717.00		91/05/29
0718.00		91/05/29
0719.00	SIGNATURE OF SENDER :	91/05/29
0720.00		91/05/29
0721.00	DATE :	91/05/29
0722.00**		93/11/25
0723.00**(fax) xxxxxxxxxxxxxxxxxxxx **confirm xxxxxxxxxxxx **form form1 **cpi 10		94/09/27
0724.00**(ref) xxxxxxxx **(ref) xxxxxxxxxxxxxxxxxxxx **end **copies 0		95/01/31
0725.00**(fax) xxxxxxxxxxxxxxxxxxxx **confirm xxxxxxxxxxxx **cpi 10		94/09/27
0726.00**(fax) xxxxxxxxxxxxxxxxxxxx **confirm xxxxxxxxxxxx **logo form1 **cpi 10		94/09/27
0727.00**Priority 0 **retries 2 **nokeep **date xx/xx/xx **time xx:xx		96/01/30
0728.00**Priority 5		96/01/30

**Source for WKCUS8P**

<i>Seq No</i>	<i>*..... 1</i>	<i>..... 2</i>	<i>..... 3</i>	<i>..... 4</i>	<i>..... 5</i>	<i>..... 6</i>	<i>..... 7</i>	<i>..... 8</i>	<i>..... 9</i>	<i>* Date Changed</i>
0001.00	FQLETSRC	IF F	92		DISK					07/03/17
0002.00	FQSYSPRT	O F	132	OA	PRINTER					90/12/13
0006.00	C		READ QLETSRC			LR				90/12/18
0008.00	C		EXCPTPRTDET							90/12/13
0009.00	C		READ QLETSRC			LR				90/12/18
0010.01	C**									11/09/14
0011.00	OQSYSPRT	H 00 1	OA							90/12/13
0012.00	O	EF 1		PRTDET						90/12/13
0013.00	O			SRCDTA	80					90/12/13

### Program Structure Chart for OE001

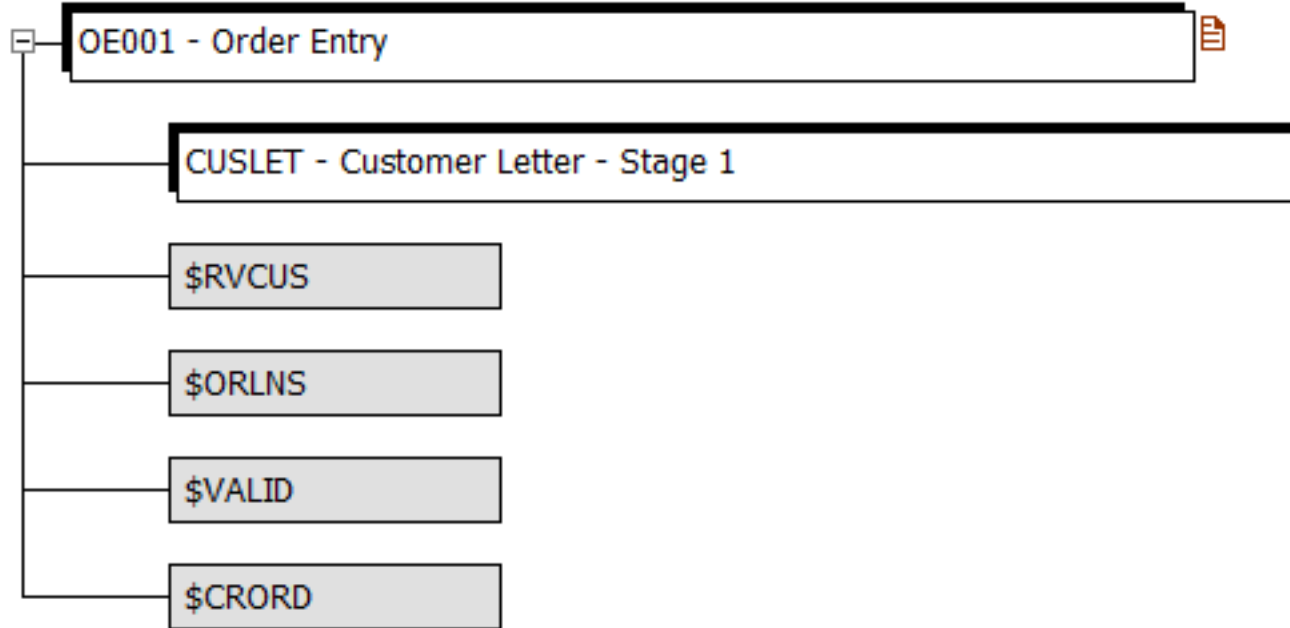



**Program Structure Chart for CUSLET**

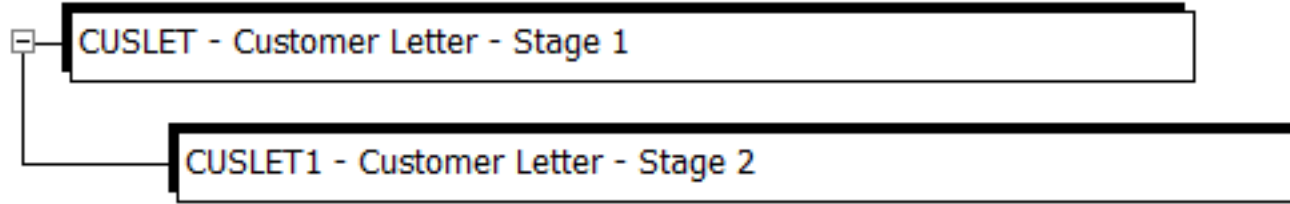

**Program Structure Chart for CUSLET1**

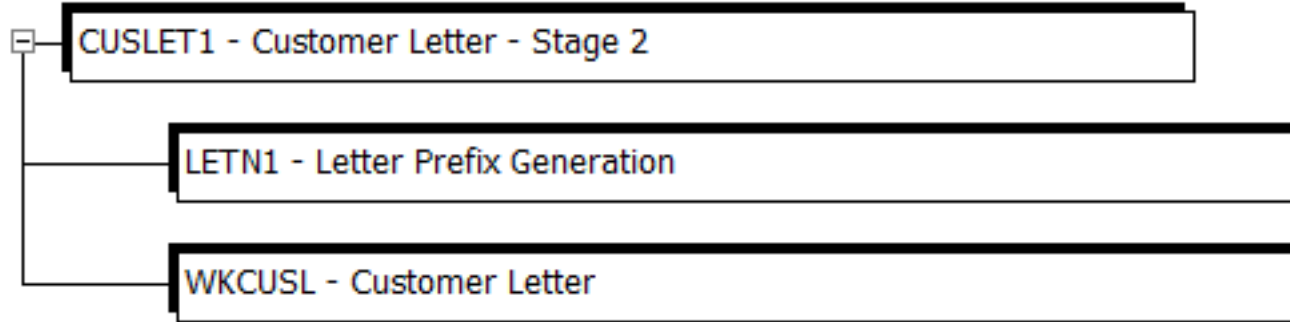

**Program Structure Chart for LETN1**

LETN1 - Letter Prefix Generation

**Program Structure Chart for WKCUSL**

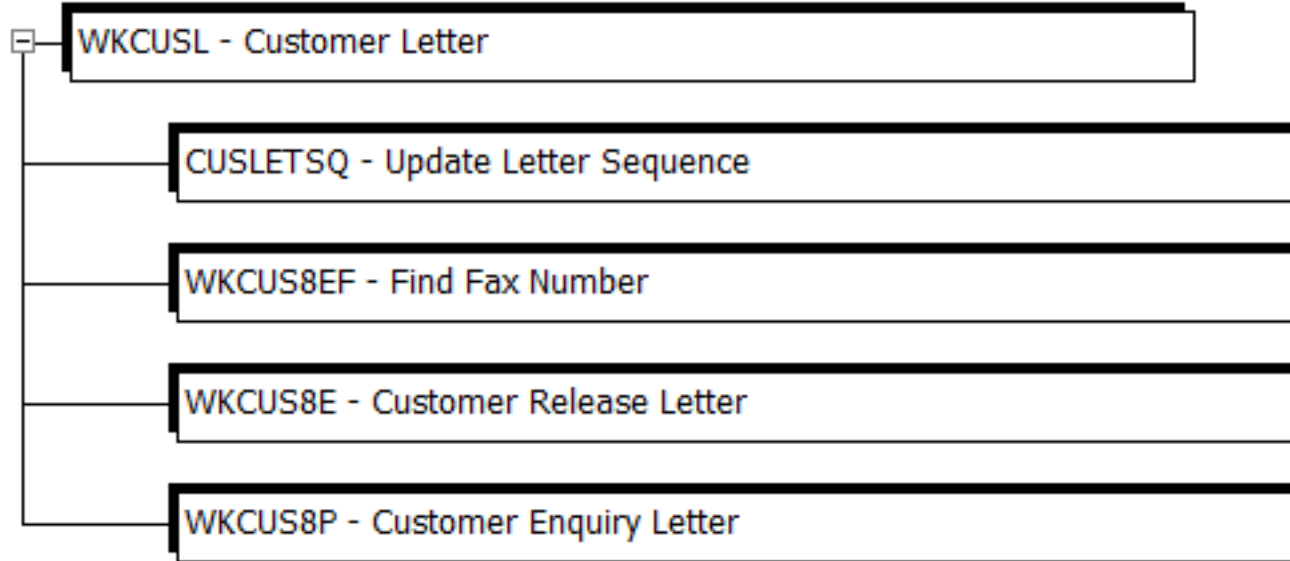

**Program Structure Chart for CUSLETSQ**

CUSLETSQ - Update Letter Sequence

**Program Structure Chart for WKCUS8EF**

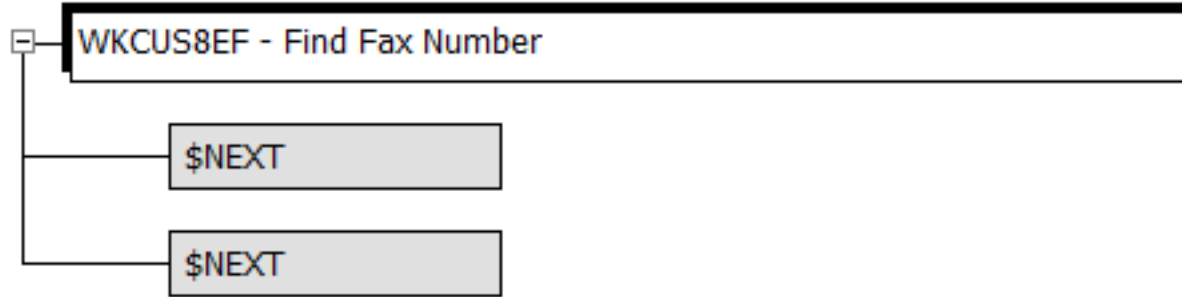

**Program Structure Chart for WKCUS8E**

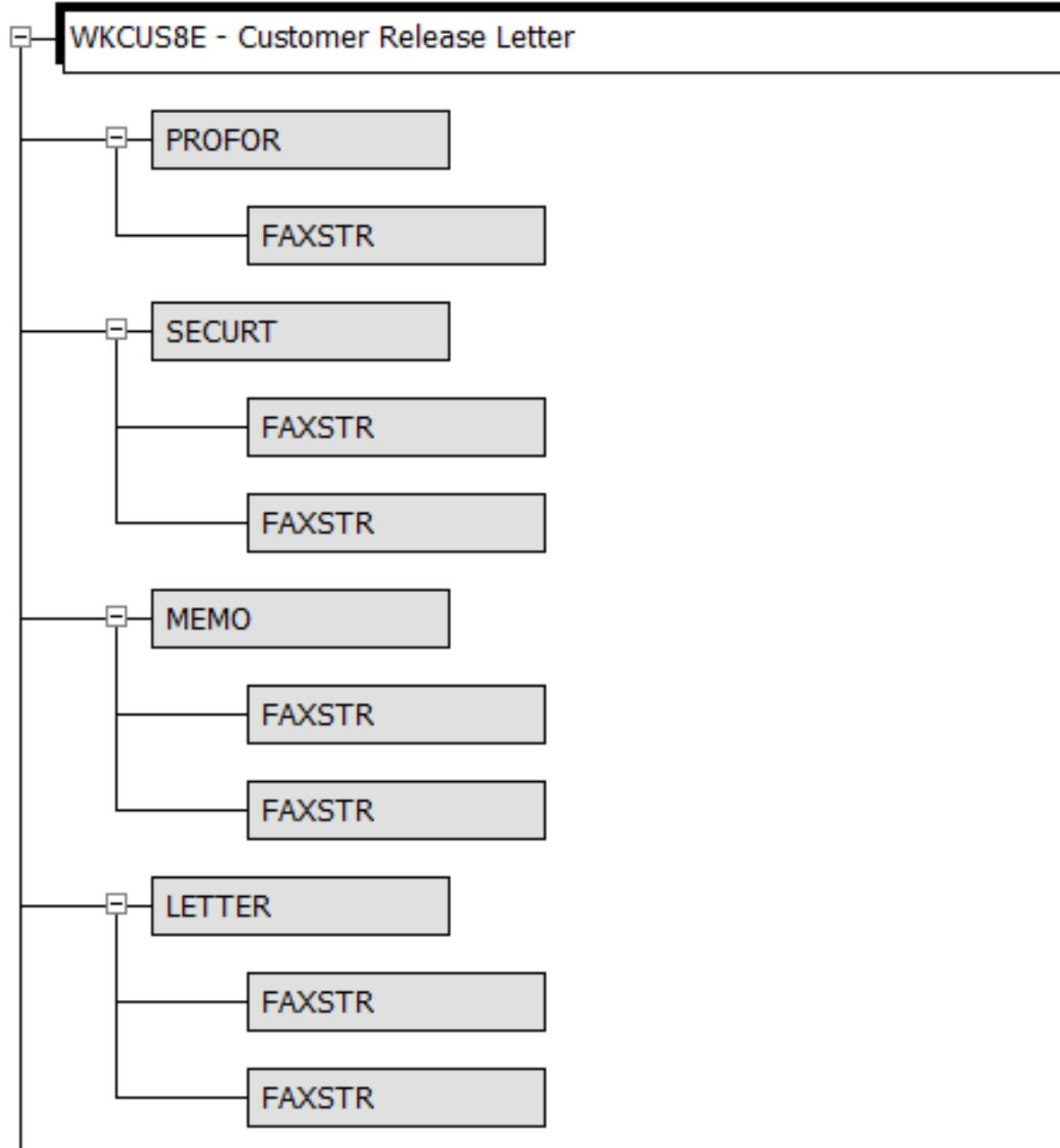

└── FAXSTR



**Program Structure Chart for WKCUS8P**

WKCUS8P - Customer Enquiry Letter

**Index**

\$CRORD, \*SBR, 165  
 \$NEXT, \*SBR, 171  
 \$ORLNS, \*SBR, 165  
 \$RVCUS, \*SBR, 165  
 \$VALID, \*SBR, 165

**C**

CB906R, \*PGM, Back-out account 73, 44  
 CBCUSTSD, \*FILE, Work with Customers 48  
 CLET, \*PGM, Build Customer Letter 66, 62  
 CLET, \*PGM, Build Customer Letter 89, 93  
 CLETN, \*PGM, Print Customer Letter 62  
 CLETN, \*PGM, Print Customer Letter 89  
 CNTDELRCD, \*PGM, 48, 73, 44, 78  
 CON001, \*PGM, Contract Entry 48, 77  
 CONSTPROC, \*PGM, PROC\_WITH\_ALL\_CONSTANTS 73, 44  
 CONUPD0, \*PGM, Revert Back Customer Info 48, 73, 74, 90, 44, 78, 63  
 CONUPD1, \*PGM, Update Customer Info - Version 1 48, 73, 74, 90, 44, 78, 63  
 CONUPD2, \*PGM, Update Customer Info - Version 2 48, 74, 90, 44, 78, 63  
 CPDM, \*PGM, List Correspondence 62  
 CPDM, \*PGM, List Correspondence 89  
 CRTVAR01, \*PGM, Embedded SQL with Create Variable Statement 73, 44  
 CUSCPY, \*PGM, Customer Copy 48, 73, 90, 44, 77, 63  
 CUSF, \*FILE, Sites 17, 22, 73, 26, 90, 11, 12, 44, 13, 126, 15, 63  
 CUSFL1, \*FILE, Sites by Name 22, 73  
 CUSFL2, \*FILE, Sites by Status 22, 73  
 CUSFL3, \*FILE, Sites by Number 129, 6, 7, 8, 40, 9, 73, 12, 149, 22, 90, 29, 63  
 CUSFL3, \*FILE, Sites by Number 96, 97, 89, 95  
 CUSFL5, \*FILE, Sites by Dist.& Status 22, 73  
 CUSFL6, \*FILE, Sites By Dist.& Name 22, 73  
 CUSFL7, \*FILE, Sites by Last Cnt.Date 22, 73  
 CUSFL8, \*FILE, Sites by Next Cnt.Date 22, 73  
 CUSFL9, \*FILE, Sites by Fax No. 22, 73  
 CUSFLA, \*FILE, Sites by Product 22, 73  
 CUSFLB, \*FILE, Sites by Orig.List 22, 73  
 CUSFLC, \*FILE, Sites by Salesperson 22, 73  
 CUSFLD, \*FILE, Sites by Validator 22, 73  
 CUSFLE, \*FILE, Sites by Organisation 22, 73  
 CUSFMAINT, \*PGM, Customer Site Maintenance 74, 90, 44, 63  
 CUSFMOLD, \*PGM, Customer Site Maintenance 74, 90, 44, 63  
 CUSFSEL, \*PGM, Customer Site Selection 73, 90, 44, 63  
 CUSLET, \*PGM, Customer Letter - Stage 1 146, 100, 5, 101, 165, 166, 87, 12, 60, 61  
 CUSLET, \*PGM, Customer Letter - Stage 1 84, 88  
 CUSLET1, \*PGM, Customer Letter - Stage 2 66, 147, 100, 5, 101, 102, 166, 167, 88, 12, 61, 62  
 CUSLET1, \*PGM, Customer Letter - Stage 2 87, 89, 93  
 CUSLETSQ, \*PGM, Update Letter Sequence 68, 100, 101, 102, 7, 104, 105, 169, 74, 170, 12, 44, 119, 152, 90, 63, 95  
 CUSLETSQ, \*PGM, Update Letter Sequence 93  
 CUSMNU, \*PGM, Customer Menu 69, 70, 71  
 CUSMNU, \*PGM, Customer Menu 96, 97, 98  
 CUSMTH, \*PGM, Update Maintenance Months 48, 78  
 CUSREAD, \*PGM, Test Sequential Read options 48, 73, 90, 44, 77, 63  
 CUSREADDEL, \*PGM, TEST SEQUENTIAL READ OPTIONS 48, 74, 90, 44, 77, 63  
 CUSRGZ, \*PGM, Reorganize Customer File 74, 91, 44, 63  
 CUSTMNT1, \*PGM, Customer Detail Maintenance 48, 73, 90, 44, 77, 63

CUSTMNT1FF, \*FILE, Customer Detail Maintenance 48  
 CUSTMNT1FM, \*FILE, Customer Detail Maintenance 48  
 CUSTMNT1\_0, \*PGM, Customer Detail Maintenance 48, 73, 90, 44, 77, 63  
 CUSTMNT1\_1, \*PGM, Customer Detail Maintenance 48, 73, 90, 44, 77, 63  
 CUSTMNT1\_2, \*PGM, Customer Detail Maintenance 48, 73, 90, 44, 77, 63  
 CUSTMNTJR, \*PGM, Customer Detail Maintenance 48, 73, 90, 44, 77, 63  
 CUSTMN\_1FM, \*FILE, Customer Detail Maintenance 48  
 CUSTRPT01, \*PGM, Customer Order Report Detail 48, 77  
 CUSTRPT02, \*PGM, Customer Transaction Report Detail 48, 77  
 CUSTS, \*FILE, Purchases 32, 48, 130, 85, 23, 58, 11, 12, 13, 77, 15  
 CUSTSL1, \*FILE, by Cus Grp/Customer 23, 77  
 CUSTSL2, \*FILE, by Representative/Customer 23, 77  
 CUSTSL3, \*FILE, by Cusno Representative 144, 4, 37, 85, 58, 12  
 CUSTSL3, \*FILE, by Cusno/Representative 34, 134, 23, 12, 77  
 CUSTSL3, \*FILE, by Cusno/Representative 84  
 CUSTSL4, \*FILE, by Distributor/Customer 23, 77  
 CUSTSL5, \*FILE, by Statement/Customer 23, 77  
 CUSTSR01, \*FILE, Customer Order Information 48  
 CUSTSR02, \*FILE, File to Store Source File Informations 48  
 CUSTSSEL, \*PGM, Customer Selection 48, 77  
 CUSUPD0, \*PGM, 48, 78  
 CUSUPD1, \*PGM, 48, 78  
 CUSUPD2, \*PGM, 48, 78

**D**

DREPORT, \*PGM, Distributor Report 73, 44  
 DSPPTYPES, \*PGM, Display Product 80, 54, 73, 74, 44

**E**

ESQLINDRF1, \*PGM, Fully Free RPG ESQL VWU Indirect References 73, 74, 44  
 ESQLINDRF2, \*PGM, Fully Free RPG ESQL VWU Indirect References 74, 44  
 ESQLINDRF3, \*PGM, Indirect references from Function Arguments 73, 44

**F**

FAXERR1, \*PGM, Faxshot Errors Part 1. 74, 91, 44, 63  
 FAXERR2, \*PGM, Faxshot Errors Part 2. 74, 91, 44, 63  
 FAXNOS1, \*PGM, Generate Fax Numbers 74, 44  
 FAXSHT, \*PGM, Immediate Faxshot 82, 55  
 FAXSHT1, \*PGM, Generate Fax Shot 69, 70, 71, 74, 44  
 FAXSHT1, \*PGM, Generate Fax Shot 96, 97, 98  
 FAXSTR, \*SBR, 172, 173  
 FXS1C, \*PGM, Special Faxshot 82, 55  
 Field List for Format OESFLC (OE00101G) 110

**G**

GCNTAC1, \*PGM, Generate Prospect Record 74, 90, 44, 63  
 GCUST1, \*PGM, Generate Purchase Record 48, 74, 90, 91, 44, 77, 63  
 GETDCOD, \*PGM, Find Customer Distributor Code 74, 90, 91, 44, 63  
 GETDCODS, \*MODULE, Find Customer Distributor Code (SRVPGM) 73, 90, 44, 63  
 GETDCODS, \*SRVPGM, 44, 76, 92, 63

**L**

LETN1, \*PGM, Letter Prefix Generation 100, 5, 101, 102, 103, 167, 168, 74, 12, 44, 148, 117, 89, 91, 62, 63  
 LETN1, \*PGM, Letter Prefix Generation 88  
 LETTER, \*SBR, 172

**M**

MEMO, \*SBR, 172

**O**

OE001, \*PGM, Order Entry 4, 100, 165, 12, 140, 77, 109, 48, 80, 112, 84, 53, 85, 54, 56, 58, 60  
 OE001, \*PGM, Order Entry 87  
 OE001DF, \*FILE, Order Entry Display 4, 53, 135, 12

OE001DF, \*FILE, Order Entry Display 84  
 OE002, \*PGM, Order Enquiry 48, 80, 85, 54, 58, 74, 91, 44, 77, 63  
 OE003, \*PGM, Product Enquiry 80, 54  
 OE004, \*PGM, Customer Enquiry/Maintenance 48, 85, 58, 77  
 OE006, \*PGM, Print Invoices 48, 80, 85, 54, 58, 74, 91, 44, 77, 63  
 OE008, \*PGM, Order Entry 48, 80, 53, 85, 54, 56, 58, 74, 91, 44, 77, 63  
 OE008, \*PGM, Order Entry 84  
 OEMENU, \*PGM, Order Entry Menu 56  
 OEMENU, \*PGM, Order Entry Menu 84  
 ORDNO, \*DTAARA, 97, 9  
 Object List 12

**P**

PROFOR, \*SBR, 172  
 PRTWCUSTP, \*PGM, 48, 77  
 PTYPES, \*FILE, Products 80, 17, 4, 36, 54, 24, 138, 11, 12, 13  
 PTYPES, \*FILE, Products 84  
 PUR01, \*PGM, Purchase Order Entry 48, 77

**Q**

QLETSRC, \*FILE, 82, 19, 7, 55, 8, 9, 139, 12  
 QLETSRC, \*FILE, 97, 98, 93  
 QRY1, \*QRYDFN, \*Q 48, 77  
 QSIGSRC, \*FILE, 97, 6, 9, 93  
 QSKLSRC, \*FILE, 97, 7, 9, 93  
 QSYSPRT, \*FILE, 98, 7, 10, 93

**S**

SEC1, \*PGM, Security Code Report 48, 77  
 SECFO, \*PGM, Reorganize Codes File 74, 90, 44, 63  
 SECFOCLP, \*PGM, Security Report 74, 91, 44, 63  
 SECURT, \*SBR, 172  
 SKLNO, \*DTAARA, Last Skeleton Letter' 6  
 SKLNO, \*DTAARA, Last Skeleton Letter' 93  
 SQLFUNC01, \*SRVPGM, SQLFUNC01 44, 76  
 SQLFUNC02, \*SRVPGM, SQLFUNC02 44, 76  
 SQLFUNC03, \*SRVPGM, SQLFUNC03 44, 76

**T**

TRIGGER1, \*PGM, Dummy Trigger program 44, 76  
 TSTPGM171, \*PGM, To tst SQL statements 48, 85, 58, 78  
 TSTPGM172, \*PGM, To tst SQL statements 48, 77

**V**

VWUOUTCOMP, \*SRVPGM, TEST\_VWU\_OUTSIDE\_COMP\_STMT 44, 76  
 VWUTSTPROC, \*PGM, PROC\_TEST\_VWU\_ON\_SQL\_QUERIES 48, 74, 44, 78, 79

**W**

WCONDETD, \*FILE, Work with Order Detail 48  
 WCONHDRD, \*FILE, Work with Orders from WWCUSTS 48  
 WCUSTP, \*PGM, Print Customer Detail 48, 74, 91, 44, 77, 63  
 WCUSTRD, \*FILE, Customer Detail Maintenance 48  
 WCUSTRP, \*FILE, Print Customer Detail 48  
 WCUSTSD, \*FILE, Work with Customer 48  
 WCUSTSD2, \*FILE, Work with Customers 48  
 WCUSTSD2FR, \*FILE, Work with Customers 48  
 WCUSTSDA, \*FILE, Work with Customer - Display File 48  
 WCUSTSDAFR, \*FILE, Work with Customer - Display File 48  
 WCUSTSDARR, \*FILE, Work with Customer - Display File 48  
 WCUSTSDFR, \*FILE, Work with Customer - Display File 48  
 WCUSTSDFRR, \*FILE, Work with Customer - Display File 48  
 WKCUS8E, \*PGM, Customer Release Letter 97, 100, 101, 70, 102, 8, 104, 169, 74, 75, 107, 12, 44, 172, 82, 55, 122, 91, 155, 63

WKCUS8E, \*PGM, Customer Release Letter 93  
 WKCUS8EF, \*PGM, Find Fax Number 96, 100, 69, 101, 102, 8, 104, 169, 74, 106, 75, 171, 12, 44, 120, 153, 91, 63  
 WKCUS8EF, \*PGM, Find Fax Number 93  
 WKCUS8P, \*PGM, Customer Enquiry Letter 98, 100, 164, 101, 102, 71, 104, 9, 169, 12, 108, 174, 111, 82, 55  
 WKCUS8P, \*PGM, Customer Enquiry Letter 93  
 WKCUSL, \*PGM, Customer Letter 66, 68, 100, 69, 101, 6, 70, 102, 71, 167, 104, 169, 12, 82, 150, 55, 93  
 WKCUSL, \*PGM, Customer Letter 96, 97, 98, 88, 95  
 WKCUSP, \*PGM, Summary Customer Report 74, 44  
 WKSECF6, \*PGM, Generate CPU Letter 69, 75, 91, 44, 63  
 WKSECF6, \*PGM, Generate CPU Letter 96  
 WKSECF6B, \*PGM, Fax CPU Details 82, 68, 55, 71  
 WKSECF6B, \*PGM, Fax CPU Details 98, 95  
 WKSECF6B3, \*PGM, Send Distribution Fax 82, 55, 71  
 WKSECF6B3, \*PGM, Send Distribution Fax 98  
 WTRNHSTD, \*FILE, Work with transaction history 48  
 WWCONDET, \*PGM, Work with Order Details 48, 77, 78  
 WWCONHDR, \*PGM, Work with Orders 48, 75, 91, 44, 77, 78, 63  
 WWCUSF, \*PGM, Work with Customer Sites 73, 90, 44, 63  
 WWCUSTS, \*PGM, Work with Customers 48, 75, 91, 44, 77, 78, 63  
 WWCUSTS2, \*PGM, Work with Customers 48, 75, 91, 44, 92, 78, 63  
 WWCUSTSARR, \*PGM, Work with Customers 48, 75, 91, 44, 78, 63  
 WWCUSTS\_0, \*PGM, Work with Customers 48, 75, 91, 44, 77, 78, 63  
 WWCUSTS\_1, \*PGM, Work with Customers 48, 75, 91, 44, 78, 63  
 WWTRNHST, \*PGM, Work with transaction history 48, 75, 91, 44, 92, 78, 63

**X**

X@VER, \*DTAARA, 7, 93  
 X\$VER, \*DTAARA, 6, 93

**Z**

ZAUDASTATU, \*PGM, Audit ASTATUS file 75, 44  
 ZAUDCUSF, \*PGM, Audit CUSF file 48, 85, 58, 75, 44, 78  
 ZAUDCUSGRP, \*PGM, Audit CUSGRP file 48, 78  
 ZAUDCUSTS, \*PGM, Audit CUSTS file 48, 78  
 ZAUIDDISTS, \*PGM, Audit DISTS file 48, 75, 44, 78  
 ZAUIDLISTS, \*PGM, Audit LISTS file 75, 44  
 ZAUIDORGS, \*PGM, Audit ORGS file 75, 44  
 ZAUIDPTYPES, \*PGM, Audit PTYPES file 80, 54, 75, 44  
 ZAUIDSLMEN, \*PGM, Audit SLMEN file 48, 78  
 ZBCONDET, \*PGM, Work with Order Details 48, 78  
 ZBCONDETNW, \*PGM, Work with Order Details -Long fields used 48, 78  
 ZBCONHDR, \*PGM, Work with Orders - Cobol vers. 48, 75, 44, 76, 92, 78, 63  
 ZBCUSFMNT, \*PGM, Customer Site Maintenance 73, 90, 44, 63  
 ZBCUSTS, \*PGM, Work with customer - Cobol vers. 48, 75, 44, 76, 92, 78, 63  
 ZBPRNCUSF, \*PGM, Print Customer Details 44, 76  
 ZBTRNHST, \*PGM, Work with transaction history 48, 44, 76, 92, 78, 63